



MITSUBISHI
PROGRAMMABLE CONTROLLERS
MELSEC-F

Changes for the Better

FX3U-ENET-ADP

USER'S MANUAL



FX3U

Safety Precautions

(Read these precautions before use.)

Before installation, operation, maintenance or inspection of this product, thoroughly read through and understand this manual and the associated manuals. Also, take care to handle the module properly and safely.

This manual classifies the safety precautions into two categories: **DANGER** and **CAUTION**.

 DANGER	Indicates that incorrect handling may cause hazardous conditions, resulting in death or severe injury.
 CAUTION	Indicates that incorrect handling may cause hazardous conditions, resulting in medium or slight personal injury or physical damage.

Depending on the circumstances, procedures indicated by **CAUTION** may also cause severe injury. In any case, it is important to follow all usage directions. Store this manual in a safe place so that it can be taken out and read whenever necessary. Always forward it to the end user.

1. DESIGN PRECAUTIONS

 DANGER	Reference
<ul style="list-style-type: none"> • Make sure to include the following safety circuits outside the PLC to ensure safe system operation even during external power supply problems or PLC failure. Otherwise, malfunctions may cause serious accidents. <ol style="list-style-type: none"> 1) Above all, the following components should be included: an emergency stop circuit, a protection circuit, an interlock circuit for opposite movements (such as normal vs. reverse rotation), and an interlock circuit (to prevent damage to the equipment at the upper and lower positioning limits). 2) Note that when the PLC main unit detects an error during self diagnosis, such as a watchdog timer error, all outputs are turned off. Also, when an error that cannot be detected by the PLC main unit occurs in an input/output control block, output control may be disabled. External circuits and mechanisms should be designed to ensure safe machinery operation in such cases. 	18

 CAUTION	Reference
<ul style="list-style-type: none"> • Observe the following items. Failure to do so may cause incorrect data-writing through noise to the PLC and result in PLC failure, machine damage or other accident. <ol style="list-style-type: none"> 1) Do not bundle the control line together with or lay it close to the main circuit or power line. As a guideline, lay the control line at least 100mm (3.94") or more away from the main circuit or power line. Noise may cause malfunctions. 2) Ground the shield wire or shield of a shielded cable. Do not use common grounding with heavy electrical systems. 	18

2. INSTALLATION PRECAUTIONS

 DANGER	Reference
<ul style="list-style-type: none"> • Make sure to cut off all phases of the power supply externally before attempting installation work. Failure to do so may cause electric shock. 	25

Safety Precautions

(Read these precautions before use.)

 CAUTION	Reference
<ul style="list-style-type: none"> • Use the product within the generic environment specifications described in PLC main unit manual (Hardware Edition). Never use the product in areas with excessive dust, oily smoke, conductive dusts, corrosive gas (salt air, Cl₂, H₂S, SO₂, or NO₂), flammable gas, vibration or impacts, or expose it to high temperature, condensation, or rain and wind. If the product is used in such conditions, electric shock, fire, malfunctions, deterioration or damage may occur. • Do not touch the conductive parts of the product directly. Doing so may cause device failures or malfunctions. • Install the product securely using a DIN rail or mounting screws. • Install the product on a flat surface. If the mounting surface is rough, undue force will be applied to the PC board, thereby causing nonconformities. • When drilling screw holes or wiring, make sure that cutting and wiring debris do not enter the ventilation slits. Failure to do so may cause fire, equipment failures or malfunctions. • Connect the FX3U-ENET-ADP securely to special adapter connector. Loose connections may cause malfunctions. 	25

3. WIRING PRECAUTIONS

 DANGER	Reference
<ul style="list-style-type: none"> • Make sure to cut off all phases of the power supply externally before attempting wiring work. Failure to do so may cause electric shock or damage to the product. 	29

 CAUTION	Reference
<ul style="list-style-type: none"> • Perform class D grounding (grounding resistance: 100 Ω or less) to the grounding terminal on the FX3U-ENET-ADP with a wire of cross-sectional area 0.5 to 1.5 mm². Do not use common grounding with heavy electrical systems (refer to the Section 5.1). • When drilling screw holes or wiring, make sure that cutting and wiring debris do not enter the ventilation slits. Failure to do so may cause fire, equipment failures or malfunctions. • Make sure to properly wire to the terminal block (European type) in accordance with the following precautions. Failure to do so may cause electric shock, equipment failures, a short-circuit, wire breakage, malfunctions, or damage to the product. <ul style="list-style-type: none"> - The disposal size of the cable end should follow the dimensions described in the manual. - Tightening torque should follow the specifications in the manual. - Twist the end of strand wire and make sure that there are no loose wires. - Do not solder-plate the electric wire ends. - Do not connect more than the specified number of wires or electric wires of unspecified size. - Affix the electric wires so that neither the terminal block nor the connected parts are directly stressed. • Make sure to observe the following precautions in order to prevent any damage to the machinery or accidents due to abnormal data written to the PLC under the influence of noise: <ol style="list-style-type: none"> 1) Do not bundle the main circuit line together with or lay it close to the main circuit, high-voltage line or load line. Otherwise, noise disturbance and/or surge induction are likely to take place. As a guideline, lay the control line at least 100mm (3.94") or more away from the main circuit or high-voltage lines. 2) Ground the shield wire or shield of the shielded cable at one point on the PLC. However, do not use common grounding with heavy electrical systems. 	29

4. STARTUP AND MAINTENANCE PRECAUTIONS

 DANGER	Reference
<ul style="list-style-type: none"> • Do not touch any terminals or connector while the PLC's power is on. Doing so may cause electrical shock or malfunctions. • Before cleaning or retightening screws, externally cut off all phases of the power supply. Failure to do so may cause malfunction or failure of this adapter. When the screws are tightened insufficiently, they may fall out and cause a shortcircuit or malfunction. When tightened too much, the screws or the adapter may be damaged, resulting in short-circuit, or malfunction. • When controlling the PLC (especially when changing data, the program or changing the operating conditions) during operation, ensure that it is safe to do so. 	18

Safety Precautions

(Read these precautions before use.)

 CAUTION	Reference
<ul style="list-style-type: none">Do not disassemble or modify the adapter. Doing so may cause fire, equipment failures, or malfunctions.The adapter case is made of resin. If dropped or subjected to strong impact, the adapter may be damaged.When this adapter is installed or removed from the panel, make sure to externally cut off all phases of the power supply. Failure to do so may cause malfunction or failure of this adapter.	18

5. DISPOSAL PRECAUTIONS

 CAUTION	Reference
<ul style="list-style-type: none">Please contact a certified electronic waste disposal company for the environmentally safe recycling and disposal of your device.	18

6. TRANSPORTATION AND STORAGE PRECAUTIONS

 CAUTION	Reference
<ul style="list-style-type: none">The product is a precision instrument. During transportation, avoid any impacts. Failure to do so may cause failures in the product. After transportation, verify the operations of the product.	18

Safety Precautions

(Read these precautions before use.)

MEMO

FX3U-ENET-ADP

User's Manual

Manual number	JY997D45801
Manual revision	A
Date	2/2012

Foreword

This manual describes the FX3U-ENET-ADP Ethernet communication special adapter and should be read and understood before attempting to install or operate the hardware. Store this manual in a safe place so that you can take it out and read it whenever necessary. Always forward it to the end user.

This manual confers no industrial property rights or any rights of any other kind, nor does it confer any patent licenses. Mitsubishi Electric Corporation cannot be held responsible for any problems involving industrial property rights which may occur as a result of using the contents noted in this manual.

Outline Precautions

- This manual provides information for the use of the FX3U-ENET-ADP Ethernet communication special adapter. The manual has been written to be used by trained and competent personnel. The definition of such a person or persons is as follows;
 - 1) Any engineer who is responsible for the planning, design and construction of automatic equipment using the product associated with this manual should be of a competent nature, trained and qualified to the local and national standards required to fulfill that role. These engineers should be fully aware of all aspects of safety with aspects regarding to automated equipment.
 - 2) Any commissioning or maintenance engineer must be of a competent nature, trained and qualified to the local and national standards required to fulfill the job. These engineers should also be trained in the use and maintenance of the completed product. This includes being familiar with all associated manuals and documentation for the product. All maintenance should be carried out in accordance with established safety practices.
 - 3) All operators of the completed equipment should be trained to use that product in a safe and coordinated manner in compliance with established safety practices. The operators should also be familiar with documentation that is connected with the actual operation of the completed equipment.
- Note:** the term 'completed equipment' refers to a third party constructed device that contains or uses the product associated with this manual.

- This product has been manufactured as a general-purpose part for general industries, and has not been designed or manufactured to be incorporated in a device or system used in purposes related to human life.
- Before using the product for special purposes such as nuclear power, electric power, aerospace, medicine or passenger movement vehicles, consult with Mitsubishi Electric.
- This product has been manufactured under strict quality control. However when installing the product where major accidents or losses could occur if the product fails, install appropriate backup or failsafe functions into the system.
- When combining this product with other products, please confirm the standards and codes of regulation to which the user should follow. Moreover, please confirm the compatibility of this product with the system, machines, and apparatuses to be used.
- If there is doubt at any stage during installation of the product, always consult a professional electrical engineer who is qualified and trained in the local and national standards. If there is doubt about the operation or use, please consult the nearest Mitsubishi Electric representative.
- Since the examples within this manual, technical bulletin, catalog, etc. are used as reference; please use it after confirming the function and safety of the equipment and system. Mitsubishi Electric will not accept responsibility for actual use of the product based on these illustrative examples.
- The content, specification etc. of this manual may be changed for improvement without notice.
- The information in this manual has been carefully checked and is believed to be accurate; however, if you notice any doubtful point, error, etc., please contact the nearest Mitsubishi Electric representative.

Registration

- Microsoft®, Windows®, Visual C++® and Visual Basic® are either registered trademarks or trademarks of Microsoft Corporation in the United States and/or other countries.
- The company name and the product name to be described in this manual are the registered trademarks or trademarks of each company.

Table of Contents

Standards	7
Certification of UL, cUL standards	7
Compliance with EC directive (CE Marking)	7
Associated Manuals	9
Generic Names and Abbreviations Used in the Manual	11
Reading the Manual	12

1. Introduction 13

1.1 Outline.....	13
1.1.1 Overview of the Ethernet adapter.....	13
1.1.2 Features of the Ethernet adapter.....	14
1.1.3 Ethernet related term.....	14
1.2 External Dimensions and Part Names	16
1.3 Pin Configuration.....	16
1.4 Power and Status LEDs	17

2. Specification 18

2.1 General Specifications	19
2.2 Power Supply Specifications.....	19
2.3 Communication Specification.....	19
2.4 Performance Specification	20
2.5 Communication function and corresponding equipment	20

3. System Configuration 21

3.1 General Configuration.....	21
3.2 Devices Required for Network Configuration	22
3.3 Applicable Systems.....	22
3.3.1 Applicable PLC.....	22
3.3.2 Applicable Software.....	22
3.4 Connection with PLC.....	23
3.5 Assignment of channels	23

4. Installation 25

4.1 FX3U-ENET-ADP Connection.....	26
4.2 DIN rail mounting	27
4.3 Direct mounting.....	28

5. Wiring 29

5.1 Grounding	29
5.2 Screw Size and Tightening Torque.....	30
5.3 Connecting to the Network.....	31
5.3.1 Applicable cable	31
5.3.2 Connecting to the 10BASE-T/100BASE-TX network	31

6. Introduction of Functions 32

6.1 Functions List	32
6.2 Details of functions	32
6.2.1 MELSOFT connections	32
6.2.2 Communication Using MC Protocol.....	32
6.2.3 MELSOFT Direct Connection (Simple Connection)	33
6.2.4 Find CPU function	33
6.2.5 Time setting function	34
6.2.6 Parameter setting function.....	36
6.2.7 The diagnostics function from MELSOFT.....	36
6.3 Setting Items List.....	37
6.4 Settings and Procedures Prior to Starting the Operation	37
6.5 Ethernet adapter Setting	38
6.6 Operational Settings.....	39
6.7 Overview of the Communication Procedure.....	40
6.8 Initial Processing	41
6.8.1 Initial processing.....	41
6.8.2 Initial settings.....	41
6.8.3 Re-initialization	41
6.9 Router Relay Parameter	41
6.10 Confirming Completion of Initial Processing	41
6.10.1 PING command (Personal computer -> Ethernet adapter)	42
6.10.2 Loop back test (Communication using MC protocol).....	43
6.11 Open Settings	43
6.12 Open Processing/Close Processing of the Connection	44

7. Communication Using MC Protocol 47

7.1 Data Codes for Communication	47
7.2 Data Communication Function	47
7.2.1 Accessing the PLC using MC protocol	48
7.2.2 How to Read the Control Procedures of the MC Protocol	48
7.2.3 Access Timing on the PLC Side	49
7.2.4 PLC setting for performing data communication	49
7.2.5 Precautions on Data Communication	50
7.3 Message Formats and Control Procedures	50
7.3.1 How to read the command reference section.....	50
7.3.2 Message format and control procedure.....	51
7.3.3 Contents of data designation items	54
7.3.4 Character area transmission data	58
7.4 List of Commands and Functions for The MC protocol.....	62
7.5 Device Memory Read/Write	64
7.5.1 Commands and device range.....	64
7.5.2 Batch read in bit units (command: 00).....	66
7.5.3 Batch write in bit units (command: 02)	68
7.5.4 Test in bit units (random write) (command: 04).....	70
7.5.5 Batch read in word units (command: 01).....	72
7.5.6 Batch write in word units (command: 03)	76
7.5.7 Test in word units (random write) (command: 05).....	80
7.6 Remote RUN/STOP, PLC model name code read	82
7.6.1 Commands and control contents.....	82
7.6.2 Remote RUN (command: 13H)/Remote STOP (Command: 14H)	83
7.6.3 PLC model name read (command: 15H).....	84
7.7 Loopback Test.....	86
7.7.1 Loopback test (command: 16H)	86

8. The Operation of GX Works2	88
8.1 Ethernet adapter Setting	88
8.2 Open Setting	90
8.2.1 MELSOFT connections	91
8.2.2 MC protocol	91
8.3 Time Setting	92
8.4 Log Record Setting	93
8.5 Online Function	94
8.5.1 Designation of destination to be connected	94
8.5.2 Find CPU function	97
8.6 Ethernet Diagnostics	99
8.6.1 Parameter status	101
8.6.2 Error history	102
8.6.3 Status of each connection, Access History	103
8.6.4 Status of each protocol	105
8.6.5 Connection Status	106
8.6.6 Time setting status	107
8.6.7 PING test	108
8.7 Print Function	111
8.7.1 Printing from the menu	111
8.7.2 Printing of the display screen	114
9. Troubleshooting	116
9.1 How to Check Errors Using LED Displays	116
9.1.1 Checking error display	116
9.1.2 How to turn off ERR. LED and to read/clear error information	117
9.2 How to Check an Error Through GX Works2	118
9.2.1 Ethernet diagnostics	118
9.3 Error Code List	119
9.3.1 Error code of Ethernet communication	119
9.3.2 End codes (completion codes) returned to an external device during data communication	123
9.3.3 Abnormal codes returned during communication using MC protocol	124
9.3.4 Communication error code inside the PLC	124
9.4 Troubleshooting Flowchart	125
9.4.1 Errors in communication using MC protocol	127
Appendix A: List of the Special Devices	129
Appendix B: Version Information	131
Appendix B-1 Version check method	131
Appendix B-2 Version upgrade history	131
Appendix C: Program Examples	132
Appendix C-1 Program example for communication using MC protocol -1	133
Appendix C-2 Program example for communication using MC protocol -2	139
Appendix D: Differences with FX3U-ENET	143

Appendix E: Document, others	145
Appendix E-1 Setting Value Recording Sheets	145
Appendix E-2 Processing Time	149
Appendix E-3 ASCII Code List.....	150
Appendix E-4 References	151
Appendix E-5 Differences between Ethernet and IEEE802.3.....	151
Appendix E-6 ICMP Protocol Supported by Ethernet adapter.....	151
Warranty.....	153
Revised History	154

Standards

Certification of UL, cUL standards

FX3U-ENET-ADP units comply with the UL standards (UL, cUL).

UL, cUL File number :E95239

Regarding the standards that comply with the main unit, please refer to either the FX series product catalog or consult with your nearest Mitsubishi product provider.

Compliance with EC directive (CE Marking)

This document does not guarantee that a mechanical system including this product will comply with the following standards.

Compliance to EMC directive and LVD directive for the entire mechanical module should be checked by the user / manufacturer. For more information please consult with your nearest Mitsubishi product provider.

Regarding the standards that comply with the main unit, please refer to either the FX series product catalog or consult with your nearest Mitsubishi product provider.

Requirement for Compliance with EMC directive

The following products have shown compliance through direct testing (of the identified standards below) and design analysis (through the creation of a technical construction file) to the European Directive for Electromagnetic Compatibility (2004/108/EC) when used as directed by the appropriate documentation.

Attention

- This product is designed for use in industrial applications.

Note

- Manufactured by:
Mitsubishi Electric Corporation
2-7-3 Marunouchi, Chiyoda-ku, Tokyo, 100-8310 Japan
- Manufactured at:
Mitsubishi Electric Corporation Himeji Works
840 Chiyoda-machi, Himeji, Hyogo, 670-8677 Japan
- Authorized Representative in the European Community:
Mitsubishi Electric Europe B.V.
Gothaer Str. 8, 40880 Ratingen, Germany

Type: Programmable Controller (Open Type Equipment)

Models: MELSEC FX3U series manufactured
from February 1st, 2012 FX3U-ENET-ADP

Standard	Remark
EN61131-2:2007 Programmable controllers - Equipment requirements and tests	Compliance with all relevant aspects of the standard. EMI • Radiated Emission • Conducted Emission EMS • Radiated electromagnetic field • Fast transient burst • Electrostatic discharge • High-energy surge • Voltage drops and interruptions • Conducted RF • Power frequency magnetic field

Caution to conform with EC Directives

- Installation in Enclosure
Programmable logic controllers are open-type devices that must be installed and used within conductive control cabinets. Please use the programmable logic controller while installed within a conductive shielded control cabinet. Please secure the cabinet door to the control cabinet (for conduction). Installation within a control cabinet greatly affects the safety of the system and aids in shielding noise from the programmable logic controller.
- Control cabinet
 - The control cabinet must be conductive.
 - Ground the control cabinet with the thickest possible grounding cable.
 - To ensure that there is electrical contact between the control cabinet and its door, connect the cabinet and its doors with thick wires.
 - In order to suppress the leakage of radio waves, the control cabinet structure must have minimal openings. Also, wrap the cable holes with a shielding cover or other shielding devices.
 - The gap between the control cabinet and its door must be as small as possible by attaching EMI gaskets between them.

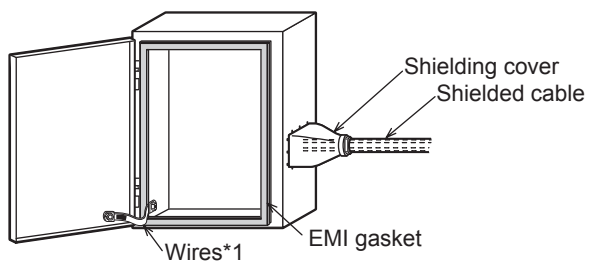

*1. These wires are used to improve the conductivity between the door and control cabinet.

Associated Manuals

Only the installation manual is packed together with the FX3U-ENET-ADP Ethernet communication special adapter.

For a detailed explanation of the FX3U-ENET-ADP Ethernet communication special adapter, refer to this manual.

For the hardware information and instructions on the PLC main unit, refer to the respective manuals.

- ⊙ Refer to these manuals
- ✓ Refer to the appropriate equipment manual
- △ For a detailed explanation, refer to an additional manual

		Title of manual	Document number	Description	Model code
Manual for the Main Module					
FX3U Series PLCs Main Unit					
△	Supplied Manual	FX3U Series Hardware Manual	JY997D18801	Describes FX3U Series PLC specification for I/O, wiring and installation extracted from the FX3U User's Manual - Hardware Edition. For details, refer to FX3U Series User's Manual - Hardware Edition.	-
⊙	Additional Manual	FX3U Series User's Manual - Hardware Edition	JY997D16501	Describes FX3U Series PLC specification details for I/O, wiring, installation and maintenance.	09R516
FX3UC Series PLCs Main Unit					
△	Supplied Manual	FX3UC(D,DS,DSS) Series Hardware Manual	JY997D28601	Describes FX3UC(D,DS,DSS) Series PLC specification for I/O, wiring and installation extracted from the FX3UC Series User's Manual - Hardware Edition. For details, refer to FX3UC Series User's Manual - Hardware Edition.	-
△	Supplied Manual	FX3UC-32MT-LT-2 Hardware Manual	JY997D31601	Describes FX3UC-32MT-LT-2 specification for I/O, wiring and installation extracted from the FX3UC User's Manual - Hardware Edition. For details, refer to FX3UC Series User's Manual - Hardware Edition.	-
△	Supplied Manual	FX3UC-32MT-LT Hardware Manual (Only Japanese document)	JY997D12701	Describes FX3UC-32MT-LT specification for I/O, wiring and installation extracted from the FX3UC User's Manual - Hardware Edition. For details, refer to FX3UC Series User's Manual - Hardware Edition.	-
⊙	Additional Manual	FX3UC Series User's Manual - Hardware Edition	JY997D28701	Describes FX3UC Series PLC specification details for I/O, wiring, installation and maintenance.	09R519
Programming					
⊙	Additional Manual	FX3G/FX3U/FX3UC Series Programming Manual - Basic & Applied Instruction Edition	JY997D16601	Describes FX3G/FX3U/FX3UC Series PLC programming for basic/applied instructions and devices.	09R517
✓	Additional Manual	MELSEC-Q/L/F Structured Programming Manual (Fundamentals)	SH-080782	Programming methods, specifications, functions, etc. required to create structured programs.	13JW06
✓	Additional Manual	FX CPU Structured Programming Manual [Device & Common]	JY997D26001	Devices, parameters, etc. provided in structured projects of GX Works2.	09R925
✓	Additional Manual	FX CPU Structured Programming Manual [Basic & Applied Instruction]	JY997D34701	Sequence instructions provided in structured projects of GX Works2.	09R926
✓	Additional Manual	FX CPU Structured Programming Manual [Application Functions]	JY997D34801	Application functions provided in structured projects of GX Works2.	09R927
✓	Additional Manual	GX Works2 Version 1 Operating Manual (Common)	SH-080779ENG	Explains the system configuration of GX Works2 and the functions common to Simple project and Structured project such as parameter setting, operation method for the online function.	13JU63

FX3U-ENET-ADP User's Manual

		Title of manual	Document number	Description	Model code
Manuals for FX3U-ENET-ADP Ethernet communication special adapter					
△	Supplied Manual	FX3U-ENET-ADP Installation Manual	JY997D45601	Describes installation specifications for the FX3U-ENET-ADP Ethernet communication special adapter extracted from the FX3U-ENET-ADP User's Manual. For details, refer to FX3U-ENET-ADP User's Manual.	-
⊙	Additional Manual	FX3U-ENET-ADP User's Manual (This Manual)	JY997D45801	Describes FX3U-ENET-ADP Ethernet communication special adapter details.	09R725

Generic Names and Abbreviations Used in the Manual

Generic name or abbreviation	Description
PLC	
FX3U series	Generic name for FX3U Series PLC
FX3U PLC or main unit	Generic name for FX3U Series PLC main unit
FX3UC series	Generic name for FX3UC Series PLC
FX3UC PLC or main unit	Generic name for FX3UC Series PLC main unit
Expansion board	Generic name for expansion board The number of connectable units, however, depends on the type of main unit. To check the number of connectable units, refer to the User's Manual - Hardware Edition of the main unit to be used for your system.
Special adapter	Generic name for high-speed input/output special adapter, communication special adapter, analog special adapter, and CF card special adapter. The number of connectable units, however, depends on the type of main unit. To check the number of connectable units, refer to the User's Manual - Hardware Edition of the main unit to be used for your system.
ENET-ADP	Abbreviated name for FX3U-ENET-ADP
I/O extension unit/block	Generic name for input/output powered extension unit and input/output extension block The number of connectable units, however, depends on the type of main unit. To check the number of connectable units, refer to the User's Manual - Hardware Edition of the main unit to be used for your system.
Special function unit/block or Special extension unit	Generic name for special function unit and special function block The number of connectable units, however, depends on the type of main unit. To check the number of connectable units, refer to the User's Manual - Hardware Edition of the main unit to be used for your system.
Special function unit	Generic name for special function unit
Special function block	Generic name for special function block
Option	
Memory cassette	Generic name for FX3U-FLROM-16, FX3U-FLROM-64, FX3U-FLROM-64L, FX3U-FLROM-1M
Peripheral unit	
Peripheral unit	Generic name for programming software, handy programming panel, and indicator
Programming tool	
Programming tool	Generic name for programming software and handy programming panel
Programming software	Generic name for programming software
GX Works2	Abbreviation of programming software packages SW□DNC-GXW2-E
Manual	
FX3U Hardware Edition	Abbreviation of FX3U Series User's Manual - Hardware Edition
FX3UC Hardware Edition	Abbreviation of FX3UC Series User's Manual - Hardware Edition
Programming manual	Abbreviation of FX3G/FX3U/FX3UC Series Programming Manual - Basic and Applied Instructions Edition

Reading the Manual

Shows the manual title.
This area shows the manual title for the current page.

Shows the title of the chapter and the title of the section.
This area shows the title of the chapter and the title of the section for the current page.

Indexes the chapter number.
The right side of each page indexes the chapter number for the page currently opened.

FX3U-ENET-ADP User's Manual
5 Wiring
5.1 Grounding

5. Wiring

WIRING PRECAUTIONS **⚠ DANGER**

- Make sure to cut off all phases of the power supply externally before attempting wiring work. Failure to do so may cause electric shock or damage to the product.

WIRING PRECAUTIONS **⚠ CAUTION**

- Perform class D grounding (grounding resistance: 100 Ω or less) to the grounding terminal on the FX3U-ENET-ADP with a wire of cross-sectional area 0.5 to 1.5 mm². Do not use common grounding with heavy electrical systems (refer to the Section 5.1).
- When drilling screw holes or wiring, make sure that cutting and wiring debris do not enter the ventilation slits. Failure to do so may cause fire, equipment failures or malfunctions.
- Make sure to properly wire to the terminal block (European type) in accordance with the following precautions. Failure to do so may cause electric shock, equipment failures, a short-circuit, wire breakage, malfunctions, or damage to the product.
 - The disposal size of the cable end should follow the dimensions described in the manual.
 - Tightening torque should follow the specifications in the manual.
 - Twist the end of strand wire and make sure that there are no loose wires.
 - Do not solder-plate the electric wire ends.
 - Do not connect more than the specified number of wires or electric wires of unspecified size.
 - Affix the electric wires so that neither the terminal block nor the connected parts are directly stressed.
- Make sure to observe the following precautions in order to prevent any damage to the machinery or accidents due to abnormal data written to the PLC under the influence of noise:
 - 1) Do not bundle the main circuit line together with or lay it close to the main circuit, high-voltage line or load line. Otherwise, noise disturbance and/or surge induction are likely to take place. As a guideline, lay the control line at least 100mm (3.94") or more away from the main circuit or high-voltage lines.
 - 2) Ground the shield wire or shield of the shielded cable at one point on the PLC. However, do not use common grounding with heavy electrical systems.

1 Introduction

2 Specification

3 System Configuration

4 Installation

5 Wiring

6 Introduction of Functions

7 Communication MC Protocol

8 The Operation of GX Works2

9 Troubleshooting

A List of Special Devices

5.1 Grounding

Ground the cables as follows

- The grounding resistance should be 100 Ω or less.
- Independent grounding should be established whenever possible. Independent grounding should be performed for best results. When independent grounding is not configured, perform "shared grounding" as shown in the following figure. For details, refer to the respective PLC manual.

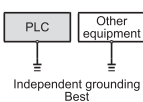

Independent grounding
Best

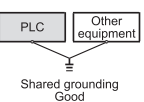

Shared grounding
Good

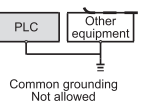

Common grounding
Not allowed

→ Refer to FX3u Hardware Edition
→ Refer to FX3uc Hardware Edition

- The grounding point should be close to the Ethernet adapter, and all grounding wires should be as short as possible.

Terminal block arrangement

Terminal name	Content
⏏ (Ground terminal)	Perform class D grounding. (Grounding resistance: 100 Ω or less)

Shows the reference.
The "→" mark indicates a reference destination and reference manual.

29

The above is different from the actual page, as it is provided for explanation only.

1. Introduction

1.1 Outline

This manual provides information on the specifications of the FX3U-ENET-ADP Ethernet communication special adapter (hereinafter called FX3U-ENET-ADP or the Ethernet adapter), as well as the procedures before starting operation, the control procedures and data communication method for communicating with external devices, and troubleshooting.

When the program examples introduced in this manual are applied to an actual system, examine the safety of the control in the target system before use.

1.1.1 Overview of the Ethernet adapter

The FX3U-ENET-ADP is an Ethernet adaptor of 10BASE-T/100BASE-TX for FX3U/FX3UC PLCs (Ver. 3.10 or later), and can be connected to a high-order system such as personal computer using the TCP/IP or UDP communication protocol.

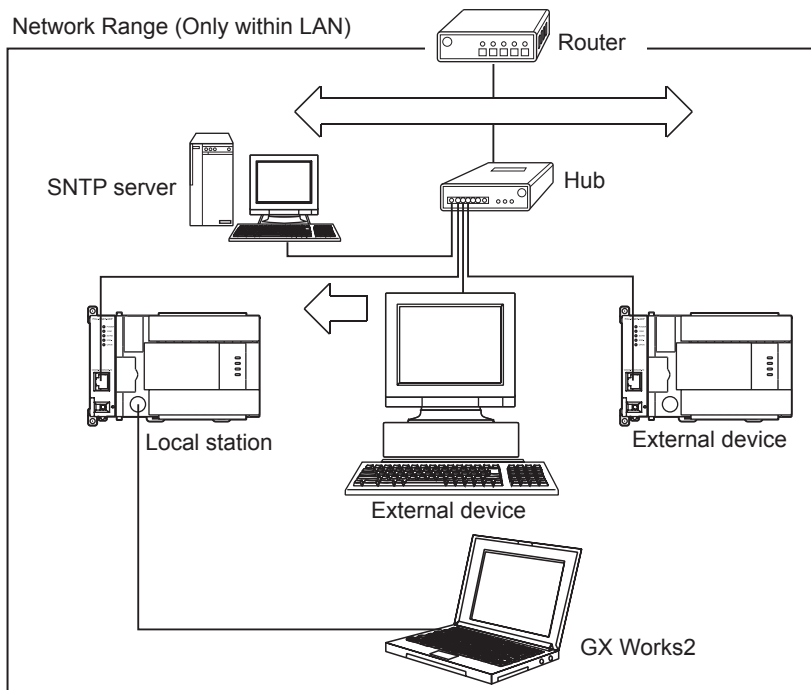

1

Introduction

2

Specification

3

System Configuration

4

Installation

5

Wiring

6

Introduction of Functions

7

Communication Using M/C Protocol

8

The Operation of GX Works2

9

Troubleshooting

A

List of Special Devices

1.1.2 Features of the Ethernet adapter

The Ethernet adapter has the following features.

- 1) Users can read and write data and programs from/to the PLC using MELSOFT products such as GX Works2 within the company LAN, etc.
- 2) Users can develop custom software to communicate with the PLC by using MC (MELSEC Communication) protocol (A-compatible 1E frame subset, for details, refer to user's manual). (TCP/IP or UDP/IP)
- 3) The FX3U-ENET-ADP can be connected directly (simple connection) to GX Works2 with only one Ethernet cable without using the hub.
- 4) Users can search "FX3U-ENET-ADP + Main unit" connected in the network using the find CPU function of GX Works2.
- 5) The FX3U-ENET-ADP can automatically set the time of the main unit using the time setting function.
- 6) The FX3U-ENET-ADP parameters can be set easily using GX Works2.
- 7) The diagnostic functions of GX Works2 enables easy diagnostics and troubleshooting of the FX3U-ENET-ADP.

1.1.3 Ethernet related term

- 1) TCP (Transmission Control Protocol)
This protocol guarantees data credibility and reliability in communication between a personal computer/work station and PLC that are connected via network, and provides the following functions:
 - Creates a logical connection by establishing a connection (logical line) as if a dedicated line was created between external devices.
 - Up to 4 connections can be established and used at the same time in the Ethernet adapter.
 - Data reliability is maintained by sequence control using the sequence numbers, the data retransmission function and check sum.
 - Communication data flow can be controlled by Windows operations.
- 2) UDP (User Datagram Protocol)
This protocol may not guarantee data credibility or reliability in communication between a personal computer/work station and PLC that are connected via network. Thus, even if the data does not reach the target node, it will not be retransmitted.
 - Because it is connectionless, communication efficiency is much improved than TCP/IP.
 - A check sum is used to increase the reliability of the communication data.
When greater reliability must be maintained, a user application or TCP should be used for the retrying operation.
- 3) IP (Internet Protocol)
 - Communication data is sent and received in datagram format.
 - Communication data can be divided and reassembled.
 - Routing option is not supported.
- 4) ARP (Address Resolution Protocol)
 - This protocol is used to get the Ethernet physical addresses from the IP addresses.
- 5) ICMP (Internet Control Message Protocol)
 - This protocol is used to exchange errors which occur on an IP network and various information related to the network.
 - Provides a function to transmit IP error messages.
 - Refer to Appendix E-6 for information regarding the types of ICMP supported.

- 6) Flag bit of TCP/IP (SYN, ACK, PSH, FIN, RST, and URG)
 In communication using TCP, these flag bits indicate segments where connection/disconnection or response confirmation is executed or emergency data is included.
- a) SYN (Synchronized Flag)
 When this bit is ON (1), it indicates that the initial sequence number value is set in the sequence number field.
 This bit is used when the connection is newly opened.
- b) ACK (Acknowledgment Flag)
 When this bit is ON (1), it indicates that ACK (confirmation response number) field is valid.
 It also indicates that this segment includes the information on response confirmation.
 When this bit is OFF (0), it indicates that ACK (confirmation response number) field is invalid.
- c) PSH (Push Flag)
 When this bit is ON (1), the host that has received this segment sends the data to the upper application with high priority.
 This bit is to be turned ON when the data should be sent to an external device as soon as possible.
 When this bit is OFF (0), the timing when the received data is sent to the upper application depends on the TCP layer of the receiving side.
- d) FIN (Fin Flag)
 When this bit is ON (1), it indicates that there is no more data to be sent from the segment source and that the send source wants to disconnect.
 However, data still can be received from the external device.
 The connection is on until the segment whose FIN bit is ON is received from the external device.
- e) RST (Reset Flag)
 When this bit is ON (1), the host from which the segment has sent disconnects unilaterally (forcibly).
 Disconnection by this method is used when an unrecoverable error with the normal method has occurred or when the host has been restored after being down.
- f) URG (Urgent Flag)
 When this bit is ON (1), it indicates that this data segment includes the emergency data flag.

1.2 External Dimensions and Part Names

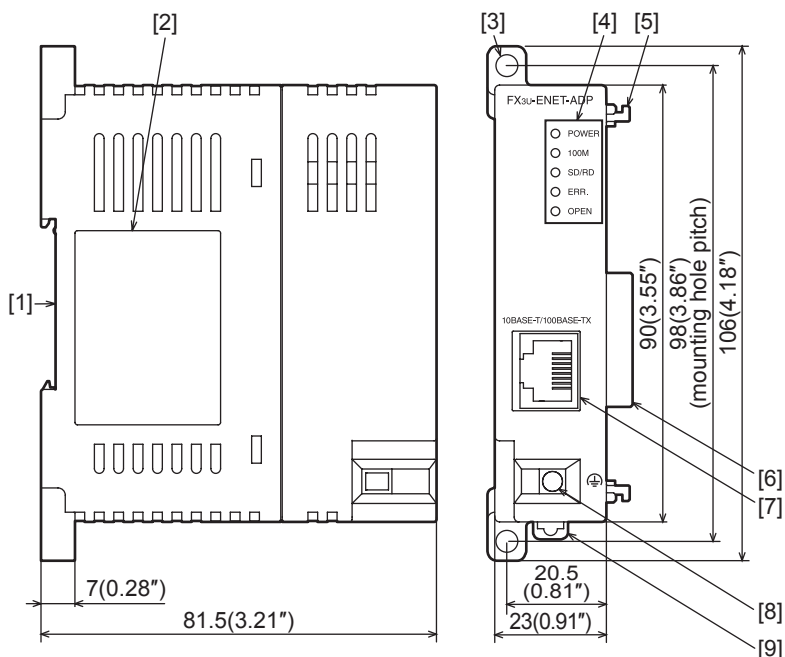

Unit: mm(inches)
 MASS(Weight): 0.1kg(0.22lbs)

- [1] DIN rail mounting groove (DIN rail: DIN46277, 35mm (1.38") width)
- [2] Nameplate
- [3] Direct mounting hole 2 holes of $\phi 4.5$ (0.18") (mounting screw: M4 screw)
- [4] Status LEDs
- [5] Special adapter fixing hook
- [6] Special adapter connector
- [7] 10BASE-T/100BASE-TX connector (RJ45)
- [8] External ground terminal (M2.5 terminal block screw)
- [9] DIN rail mounting hook

1.3 Pin Configuration

The pin configuration of FX3U-ENET-ADP RJ45 type modular jack is as follows:

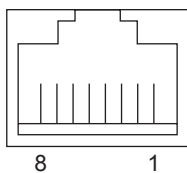

Pin No.	Signal	Direction	Contents
1	TD+	Out	+ side of sending data
2	TD-	Out	- side of sending data
3	RD+	In	+ side of receiving data
4	Not used	-	
5	Not used	-	
6	RD-	In	- side of receiving data
7	Not used	-	
8	Not used	-	

1.4 Power and Status LEDs

LED display	LED Color	Status	Description
POWER	Green	ON	Power is on
		OFF	Power is off
100M	Green	ON	100Mbps communication
		OFF	10Mbps communication or not connected
SD/RD	Green	ON	Data being sent or received.
		OFF	Data is not sent or received.
ERR.	Red	ON	Setting errors, hardware errors, etc.
		Flicker	Communication errors
		OFF	Setting normal, communication normal
OPEN	Green	ON*1	TCP/IP: 1 or more connections are established. UDP: 1 or more connections are open.
		OFF	TCP/IP: All connections are unestablished. UDP: All connections are closed.

*1. In direct connection (simple connection), "OPEN" LED does not turn on.

1

Introduction

2

Specification

3

System Configuration

4

Installation

5

Wiring

6

Introduction of Functions

7

Communication Using M/C Protocol

8

The Operation of GX Works2

9

Troubleshooting

A

List of Special Devices

2. Specification

DESIGN PRECAUTIONS



- Make sure to include the following safety circuits outside the PLC to ensure safe system operation even during external power supply problems or PLC failure.
Otherwise, malfunctions may cause serious accidents.
 - 1) Above all, the following components should be included: an emergency stop circuit, a protection circuit, an interlock circuit for opposite movements (such as normal vs. reverse rotation), and an interlock circuit (to prevent damage to the equipment at the upper and lower positioning limits).
 - 2) Note that when the PLC main unit detects an error during self diagnosis, such as a watchdog timer error, all outputs are turned off. Also, when an error that cannot be detected by the PLC main unit occurs in an input/output control block, output control may be disabled.
External circuits and mechanisms should be designed to ensure safe machinery operation in such cases.

DESIGN PRECAUTIONS



- Observe the following items. Failure to do so may cause incorrect data-writing through noise to the PLC and result in PLC failure, machine damage or other accident.
 - 1) Do not bundle the control line together with or lay it close to the main circuit or power line.
Noise may cause malfunctions.
As a guideline, lay the control line at least 100mm (3.94") or more away from the main circuit or power line.
 - 2) Ground the shield wire or shield of a shielded cable. Do not use common grounding with heavy electrical systems.

STARTUP AND MAINTENANCE PRECAUTIONS



- Do not touch any terminals or connector while the PLC's power is on.
Doing so may cause electrical shock or malfunctions.
- Before cleaning or retightening screws, externally cut off all phases of the power supply.
Failure to do so may cause malfunction or failure of this adapter. When the screws are tightened insufficiently, they may fall out and cause a shortcircuit or malfunction. When tightened too much, the screws or the adapter may be damaged, resulting in short-circuit, or malfunction.
- When controlling the PLC (especially when changing data, the program or changing the operating conditions) during operation, ensure that it is safe to do so.

STARTUP AND MAINTENANCE PRECAUTIONS



- Do not disassemble or modify the adapter.
Doing so may cause fire, equipment failures, or malfunctions.
- The adapter case is made of resin. If dropped or subjected to strong impact, the adapter may be damaged.
- When this adapter is installed or removed from the panel, make sure to externally cut off all phases of the power supply. Failure to do so may cause malfunction or failure of this adapter.

DISPOSAL PRECAUTIONS



- Please contact a certified electronic waste disposal company for the environmentally safe recycling and disposal of your device.

TRANSPORTATION AND STORAGE PRECAUTIONS



- The product is a precision instrument. During transportation, avoid any impacts. Failure to do so may cause failures in the product.
After transportation, verify the operations of the product.

2.1 General Specifications

For items not listed below, specifications are the same as those of the PLC main unit.
For general specifications, refer to the manual of the PLC main unit.

→ Refer to FX3U Hardware Edition.
→ Refer to FX3UC Hardware Edition.

Item	Specification	
Dielectric withstand voltage	500 V AC for one minute	Between PLC all terminals and ground terminal
Insulation resistance	5 MΩ or more by 500 V DC Megger	

2.2 Power Supply Specifications

Item	Specification
Adapter driving power supply	30mA / 5V DC 5V DC power is supplied internally from the main unit.
Permitted instantaneous power failure time	Same as connected PLC

2.3 Communication Specification

Item	Specification	
Transmission specifications	Data transmission speed	100Mbps/10Mbps
	Communication method	Full-duplex/Half-duplex
	Transmission method	Base band
	Maximum segment length	100m (328'1")
	Maximum number of nodes/connection	10BASE-T
100BASE-TX		Cascade connection maximum 2 stages ^{*1}
Connector	RJ45	

*1. The value indicates the number of connectable stages when the repeater hub is used.
Contact the manufacturer of the switching hub for the number of connectable stages when using the switching hub.

When connecting Ethernet adapter to a network, either a 10BASE-T or 100BASE-TX can be used.
The Ethernet adapter can be connected directly to the personal computer without using the hub.
The ports must comply with the IEEE802.3 10BASE-T or IEEE802.3 100BASE-TX standards.

Caution

- The Ethernet adapter detects whether it is 10BASE-T or 100BASE-TX, and full-duplex or half-duplex transmission mode according to the hub. (auto detection function)
For connection to the hub without the auto detection function, set half-duplex mode on the hub side.
- The module operation is not guaranteed if any of the following connections are used.
 - Connections using the Internet (general public line) (Connections using Internet connection service provided by Internet service providers and telecommunications carriers)
 - Connections using devices in which a firewall is installed
 - Connections using broadband routers
 - Connections using wireless LAN

2.4 Performance Specification

Item	Specification
Functions	MELSOFT connections
	Communication Using MC Protocol
	MELSOFT Direct Connection (Simple Connection)
	Find CPU function
	Time setting function*1
	Diagnostics function from MELSOFT
Number of simultaneously open connections allowed	MELSOFT connection + MC protocol <= 4
Number of connectable units to the main unit	1 unit*2

*1. The time setting function (SNTP client) is enabled only after the trigger condition is established.

*2. The Ethernet adapter occupies 1 communication channel in the same way as (communication expansion boards and) other communication special adapters.

2.5 Communication function and corresponding equipment

This section explains with which external devices data communication can be performed and which additional functions can be used for each function.

- 1) Ability to communicate with external devices using various functions

The following table lists with which external devices communication is possible using various functions.

Function	External device		
	Personal computer ↓ FX3U-ENET-ADP	Personal computer ↑ FX3U-ENET-ADP	FX3U-ENET-ADP ↓ ↑ FX3U-ENET-ADP
Communication using MC protocol	✓	✗	✗

✓ : Can communicate ✗ : Cannot communicate

- 2) Relationship with additional functions

The following table lists the relationship between functions and any additional functions that can be used.

Function	Additional function		Communication method	
	Router relay communication (router relay function)	Existence check of external device	TCP/IP	UDP/IP
Communication using MC protocol	✓	✓	✓	✓

✓ : Available ✗ : Not available

3. System Configuration

This section explains the system configurations that may be used with the Ethernet adapter.

3.1 General Configuration

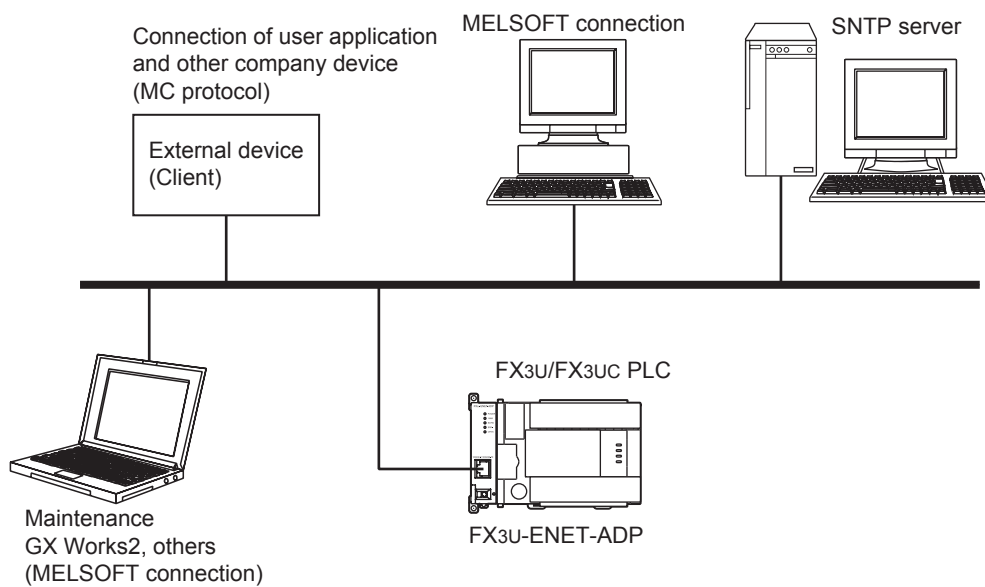

Component list

Part name	Model name	Remarks
Ethernet adapter	FX3U-ENET-ADP	An expansion board is required to connect the FX3U-ENET-ADP with the FX3U/FX3UC-32MT-LT(-2) PLCs.
PLC	FX3U/FX3UC PLC	-
PC software	GX Works2	PLC programming software. This software writes various settings for the Ethernet adapter.
Personal computer	-	-
HUB ^{*1}	-	Use an industrial product.
SNTP server ^{*2}	-	-
External device	-	MC protocol conforming device
Ethernet cable	-	10BASE-T: Category 3 or better (STP cable ^{*3}) 100BASE-TX: Category 5 or better (STP cable ^{*3})

*1. A hub is not used in direct connection (simple connection) etc.

*2. Time information server.

*3. Shielded twisted pair cable.

1	Introduction
2	Specification
3	System Configuration
4	Installation
5	Wiring
6	Introduction of Functions
7	Communication Using MC Protocol
8	The Operation of GX Works2
9	Troubleshooting
A	List of Special Devices

3.2 Devices Required for Network Configuration

This section explains the devices that are required to configure a network. Network installation work requires sufficient safeguards; ask a network specialist for installation. When connecting the Ethernet adapter to a network, either 10BASE-T or 100BASE-TX can be used. The Ethernet adapter detects whether it is 10BASE-T or 100BASE-TX, and full-duplex or half-duplex transmission mode according to the hub. (Auto detection function)
For connection to the hub without the auto detection function, set half-duplex mode on the hub side.

1) Connection using 100BASE-TX

Use devices that satisfy the standards of IEEE802.3 and 100BASE-TX.

- Shielded twisted pair cable (STP cable), category 5 or better
Use a straight cable for connection between a hub and the Ethernet adapter.
(A cross cable can also be used when connecting the Ethernet adapter directly to the external device, not through a hub.)
- RJ45 plug
- 100Mbps hub

2) Connection using 10BASE-T

Use devices that satisfy the standards of IEEE802.3 and 10BASE-T.

Use devices that satisfy the standards of IEEE802.3 and 100BASE-TX.

- Shielded twisted pair cable (STP cable), category 3 or better
Use a straight cable for connection between a hub and the Ethernet adapter.
(A cross cable can also be used when connecting the Ethernet adapter directly to the external device, not through the hub.)
- RJ45 plug
- 10Mbps hub

3.3 Applicable Systems

3.3.1 Applicable PLC

Model name	Applicability
FX3U Series PLC*1	Ver. 3.10 and later Only one FX3U-ENET-ADP unit can be connected to a main unit.
FX3UC Series PLC*1	Ver. 3.10 and later Only one FX3U-ENET-ADP unit can be connected to a main unit.

The version number can be checked by reading the last three digits of device D8001 or D8101.

*1. An expansion board is required to connect the FX3U-ENET-ADP with FX3U/FX3UC-32MT-LT(-2) PLCs.

3.3.2 Applicable Software

1. GX Works2

Use the following version when setting the Ethernet adapter or using the MELSOFT connection function.

Software	Applicability
GX Works2 • SW□DNC-GXW2-E	Ver. 1.73B or later

Caution

- If an older version is used, programming will not be possible.
- In order to set up the Ethernet adapter via GX Works2, FX Configurator-EN needs to be installed.

3.4 Connection with PLC

The Ethernet adapter connects to a FX3U/FX3UC PLC via a special adapter connector. Only one Ethernet adapter can be connected to the FX3U/FX3UC PLC. An expansion board is required to connect the Ethernet adapter with the FX3U/FX3UC-32MT-LT(-2) PLCs. The Ethernet adapter must be connected at the last stage (left end) of adapters for the FX3U/FX3UC PLC.

1. FX3U/FX3UC-32MT-LT(-2) PLC

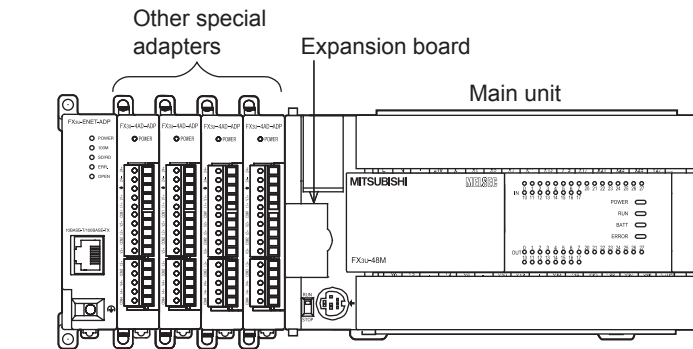

FX3U-ENET-ADP

2. FX3UC(D, DS, DSS) PLC

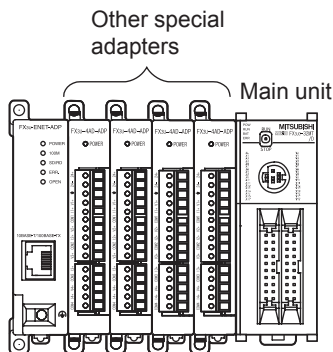

FX3U-ENET-ADP

3.5 Assignment of channels

The Ethernet adapter is a communication special adapter for PLCs, and channel numbers (such as CH1 and CH2) are automatically assigned starting from the adapter nearest the main unit. This channel number is used in GX Works2.

Only one Ethernet adapter can be connected at the last stage (left end) of adapters. When another communication expansion board/communication special adapter (including the FX3U-8AV-BD and FX3U-CF-ADP) is connected to the FX3U/FX3UC PLC, "CH2" is assigned to the Ethernet adapter.

The channel number is assigned as shown below.

1. FX3U/FX3UC-32MT-LT(-2) PLC

- When not using other communication expansion board/communication special adapter (CH1)

CH1

FX3U-ENET-ADP	Analog special adapter	Analog special adapter	FX3U-CNV-BD	FX3U, FX3UC-32MT-LT(-2) Main unit
---------------	------------------------	------------------------	-------------	-----------------------------------

1 Introduction
2 Specification
3 System Configuration
4 Installation
5 Wiring
6 Introduction of Functions
7 Communication Using M/C Protocol
8 The Operation of GX Works2
9 Troubleshooting
A List of Special Devices

- When using other communication expansion board/communication special adapter (CH2)

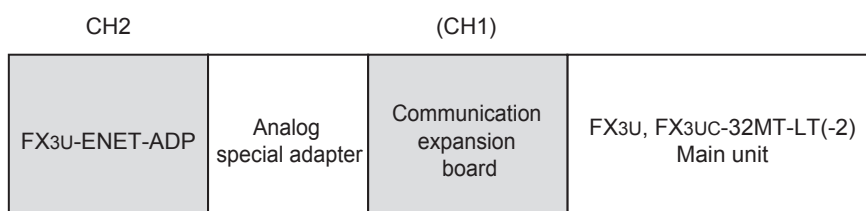

Caution on using the Ethernet adapter

The Ethernet adapter is a communication special adapter, and occupies 1 communication channel. When the Ethernet adapter is used, only one other communication expansion board/communication special adapter (including the FX3U-8AV-BD and FX3U-CF-ADP) can be connected to the FX3U/FX3UC-32MT-LT(-2) PLC.

2. FX3UC(D, DS, DSS) PLC

- When not using other communication special adapter (CH1)

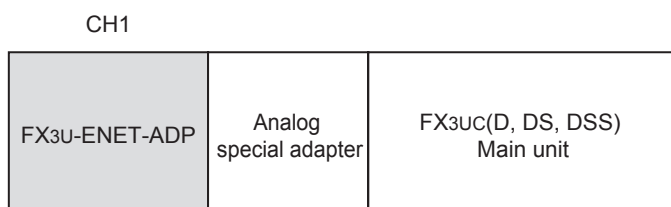

- When using other communication special adapter (CH2)

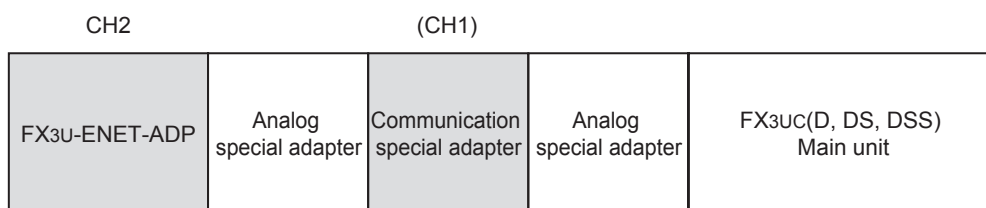

Caution on using the Ethernet adapter

The Ethernet adapter is a communication special adapter, and occupies 1 communication channel. When the Ethernet adapter is used, only one other communication special adapter (including the FX3U-CF-ADP) can be connected to the FX3UC (D, DS, DSS) PLC.

4. Installation

INSTALLATION PRECAUTIONS	 DANGER
<ul style="list-style-type: none"> • Make sure to cut off all phases of the power supply externally before attempting installation work. Failure to do so may cause electric shock. 	

INSTALLATION PRECAUTIONS	 CAUTION
<ul style="list-style-type: none"> • Use the product within the generic environment specifications described in PLC main unit manual (Hardware Edition). Never use the product in areas with excessive dust, oily smoke, conductive dusts, corrosive gas (salt air, Cl2, H2S, SO2, or NO2), flammable gas, vibration or impacts, or expose it to high temperature, condensation, or rain and wind. If the product is used in such conditions, electric shock, fire, malfunctions, deterioration or damage may occur. • Do not touch the conductive parts of the product directly. Doing so may cause device failures or malfunctions. • Install the product securely using a DIN rail or mounting screws. • Install the product on a flat surface. If the mounting surface is rough, undue force will be applied to the PC board, thereby causing nonconformities. • When drilling screw holes or wiring, make sure that cutting and wiring debris do not enter the ventilation slits. Failure to do so may cause fire, equipment failures or malfunctions. • Connect the FX3U-ENET-ADP securely to special adapter connector. Loose connections may cause malfunctions. 	

- 1** Introduction
- 2** Specification
- 3** System Configuration
- 4** Installation
- 5** Wiring
- 6** Introduction of Functions
- 7** Communication Using M/C Protocol
- 8** The Operation of GX Works2
- 9** Troubleshooting
- A** List of Special Devices

4.1 FX3U-ENET-ADP Connection

An expansion board should be installed before connecting the Ethernet adapter. An expansion board is not required when the Ethernet adapter is connected to a FX3uc(D, DS, DSS) PLC.

This section explains an example where the Ethernet adapter is connected to a FX3u PLC. For connection to another PLC, refer to the respective PLC manual.

→ Refer to FX3u Hardware Edition
→ Refer to FX3uc Hardware Edition

1 Remove the special adapter connector cover (A in the figure on the right) from the expansion board.

It is assumed that an expansion board has been installed in advance. For the expansion board installation method, refer to the respective PLC manual.

→ Refer to FX3u Hardware Edition
→ Refer to FX3uc Hardware Edition

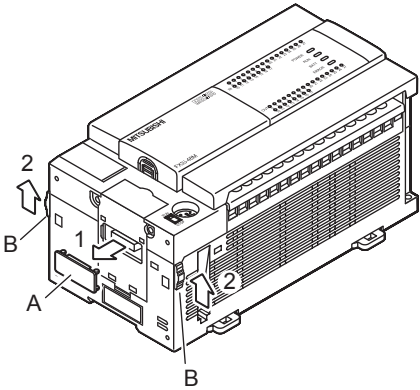

2 Slide the special adapter connecting hooks (B in the figure on the right) of the main unit upwards.

3 Connect the Ethernet adapter (C in the figure on the right) to the main unit as shown in the figure on the right.

4 Slide the special adapter connecting hooks (B in the figure on the right) of the main unit downwards to secure the Ethernet adapter (C in the figure on the right).

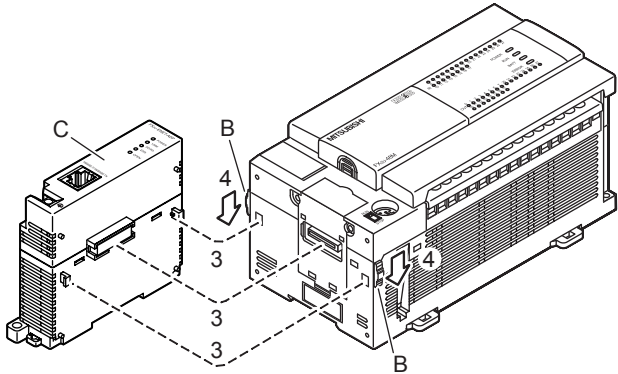

Caution on connection

Only one FX3U-ENET-ADP unit can be connected in the final stage (leftmost position) of the main unit, special adapter, etc.

Connect all the high-speed I/O special adapters before connecting other special adapters when they are used in combination.

Do not connect a high-speed I/O special adapter on the left side of any special adapters other than other high-speed I/O special adapters.

4.2 DIN rail mounting

The Ethernet adapter may be mounted on a 35mm (1.38") wide DIN46277 (DIN rail). Connect the Ethernet adapter to the PLC main unit before attaching the Ethernet adapter to a DIN rail. This section explains an example where the Ethernet adapter is connected to a FX3U PLC. For the DIN rail mounting method for other PLCs, refer to the respective PLC manual.

→ Refer to FX3U Hardware Edition
→ Refer to FX3UC Hardware Edition

1 Push out all DIN rail mounting hooks (A in the figure on the right).

It is assumed that the Ethernet adapter has been connected in advance. For the Ethernet adapter connection method, refer to the following.

→ Refer to Section 4.1

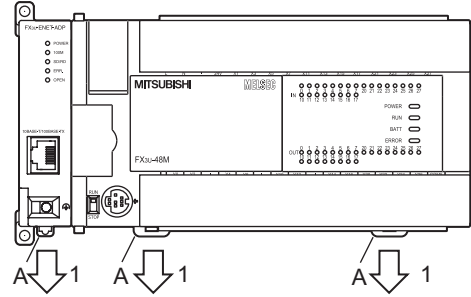

2 Fit the upper edge (B in the figure on the right) of the DIN rail mounting groove onto the DIN rail.

3 Push the product onto the DIN rail.

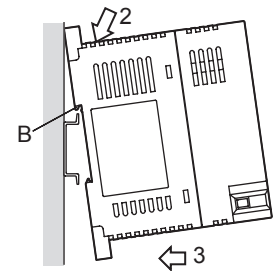

4 Lock the DIN rail mounting hooks (A in the following figure) while pressing the PLC against the DIN rail.

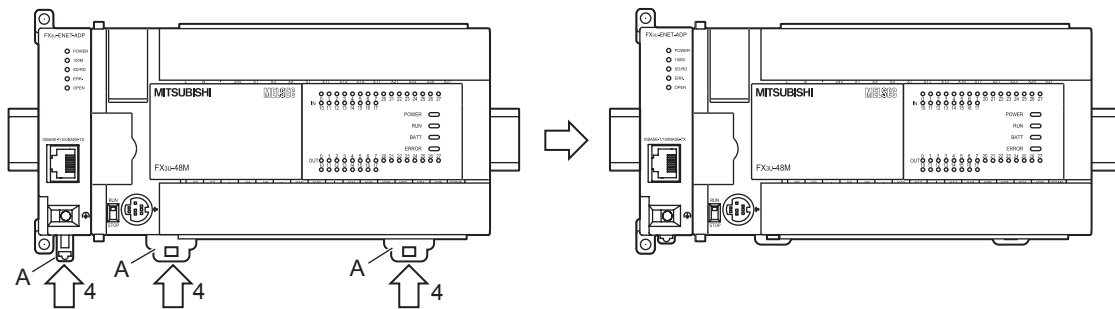

1	Introduction
2	Specification
3	System Configuration
4	Installation
5	Wiring
6	Introduction of Functions
7	Communication Using M/C Protocol
8	The Operation of GX Works2
9	Troubleshooting
A	List of Special Devices

4.3 Direct mounting

When the Ethernet adapter is connected to a FX3U PLC, the Ethernet adapter may be mounted directly on a panel surface using screws. The direct mounting method is not available when the Ethernet adapter is connected to a FX3UC PLC. Connect the Ethernet adapter to the main unit before attaching it to the panel surface.

For mounting, refer to the following manual.

→ Refer to FX3U Hardware Edition

1 Create mounting holes in the mounting surface according to the external dimensions diagram.

2 Fit the Ethernet adapter to the mounting holes and tighten with M4 screws (A in the figure on the right).

Also fit the main unit to the mounting holes and tighten with M4 screws. For the main unit connection method, refer to the following.

→ Refer to FX3U Hardware Edition

It is assumed that the Ethernet adapter has been connected in advance.

For the Ethernet adapter connection method, refer to the following.

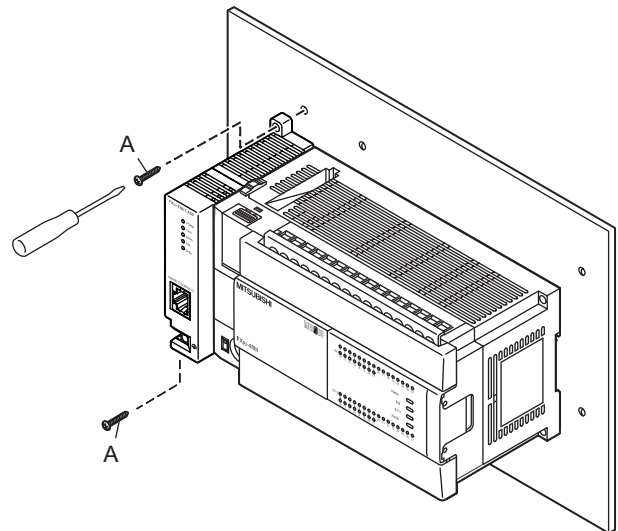

→ Refer to Section 4.1

For the screw positions and number of screws in the Ethernet adapter, refer to the dimensional outline drawing as follows.

→ Refer to Section 1.2

For the screw positions and number of screws in the main unit, refer to the following manual.

→ Refer to FX3U Hardware Edition

5. Wiring

WIRING PRECAUTIONS	DANGER
<ul style="list-style-type: none"> • Make sure to cut off all phases of the power supply externally before attempting wiring work. Failure to do so may cause electric shock or damage to the product. 	

WIRING PRECAUTIONS	CAUTION
<ul style="list-style-type: none"> • Perform class D grounding (grounding resistance: 100 Ω or less) to the grounding terminal on the FX3U-ENET-ADP with a wire of cross-sectional area 0.5 to 1.5 mm². Do not use common grounding with heavy electrical systems (refer to the Section 5.1). • When drilling screw holes or wiring, make sure that cutting and wiring debris do not enter the ventilation slits. Failure to do so may cause fire, equipment failures or malfunctions. • Make sure to properly wire to the terminal block (European type) in accordance with the following precautions. Failure to do so may cause electric shock, equipment failures, a short-circuit, wire breakage, malfunctions, or damage to the product. <ul style="list-style-type: none"> - The disposal size of the cable end should follow the dimensions described in the manual. - Tightening torque should follow the specifications in the manual. - Twist the end of strand wire and make sure that there are no loose wires. - Do not solder-plate the electric wire ends. - Do not connect more than the specified number of wires or electric wires of unspecified size. - Affix the electric wires so that neither the terminal block nor the connected parts are directly stressed. • Make sure to observe the following precautions in order to prevent any damage to the machinery or accidents due to abnormal data written to the PLC under the influence of noise: <ol style="list-style-type: none"> 1) Do not bundle the main circuit line together with or lay it close to the main circuit, high-voltage line or load line. Otherwise, noise disturbance and/or surge induction are likely to take place. As a guideline, lay the control line at least 100mm (3.94") or more away from the main circuit or high-voltage lines. 2) Ground the shield wire or shield of the shielded cable at one point on the PLC. However, do not use common grounding with heavy electrical systems. 	

5.1 Grounding

Ground the cables as follows

- The grounding resistance should be 100 Ω or less.
- Independent grounding should be established whenever possible. Independent grounding should be performed for best results. When independent grounding is not configured, perform "shared grounding" as shown in the following figure. For details, refer to the respective PLC manual.

→ Refer to FX3U Hardware Edition
→ Refer to FX3UC Hardware Edition

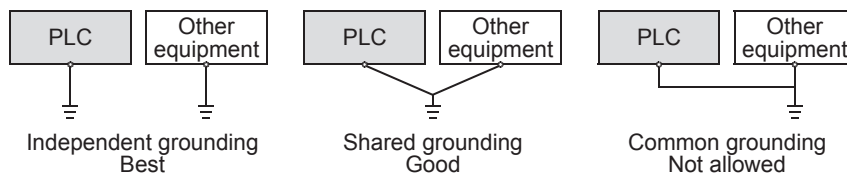

- The grounding point should be close to the Ethernet adapter, and all grounding wires should be as short as possible.

Terminal block arrangement

Terminal name	Content
 (Ground terminal)	Perform class D grounding. (Grounding resistance: 100 Ω or less)

Grounding wiring

Example usage of FX3U

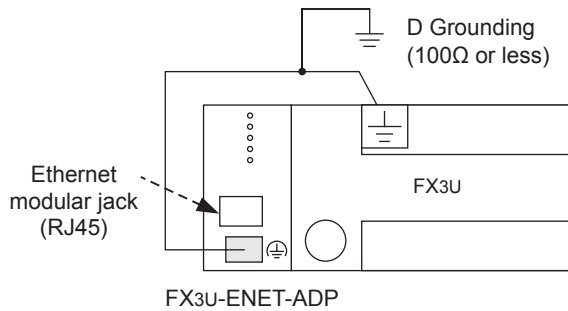
**Applicable cables**

Electric wire size
0.5 to 1.5 mm ² (AWG 20 to 16)

- When using a stranded cable or solid cable as it is
 - Twist the end of the stranded cable so that loose wires will not stick out.
 - Do not solder-plate the end of the cable.

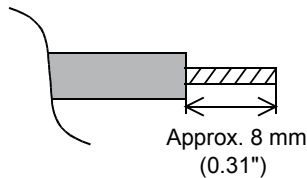
**5.2 Screw Size and Tightening Torque**

The grounding terminal of the Ethernet adapter is a M2.5 screw.

Set the tightening torque to 0.4 to 0.5 N·m.

Terminal screws must be secured to prevent a loose connection thus avoiding a malfunction.

Failure to do so may cause equipment failures or malfunctions.

Caution

When tightening a grounding terminal, use a screwdriver suitable for the terminal screw. The screwdriver which does not suit the thread groove is used, tightening torque will not be able to be achieved. To achieve the appropriate tightening torque shown in the above, use the following screwdriver or an appropriate replacement.

<Reference>

Manufacturer	Model name	Model number
Weidmuller Interface GmbH & Co. KG	SDIK PH0	9008560000
Weidmuller Interface GmbH & Co. KG	SD 0.6 × 3.5 × 100	9008330000

5.3 Connecting to the Network

The following explains how to connect the Ethernet adapter to 10BASE-T/100BASE-TX networks. Pay close attention to safety and use the Ethernet adapter properly.

- 1) Sufficient network knowledge and safety precautions are required when installing 10BASE-T or 100BASE-TX networks. Consult a specialist when connecting cable terminals or installing trunk line cables, etc.
- 2) Use a connection cable conforming to the standards shown in Subsection 5.3.1.

Cautions regarding powering the hub, PLC and Ethernet adapter simultaneously.

On some hubs, for a fixed period of time immediately after powering up, even if packets are sent from the Ethernet device, there are cases when packets are not sent to the external device. In this case, create a sequence program that waits a sufficient amount of time after powering up before sending packets.

5.3.1 Applicable cable

The following should be used for the Ethernet cable.

Item	Specification
10BASE-T	Cable conforming to Ethernet standard practice: Category 3 or better (STP cable *1)
100BASE-TX	Cable conforming to Ethernet standard practice: Category 5 or better (STP cable *1)

*1. Shielded twisted pair cable.

- A straight cable is used. A cross cable can also be used when using direct connection (simple connection) between the personal computer and the Ethernet adapter.

5.3.2 Connecting to the 10BASE-T/100BASE-TX network

This section explains how to connect the Ethernet adapter to the 10BASE-T, 100BASE-TX network. The following shows the connection diagram for the twisted pair cable.

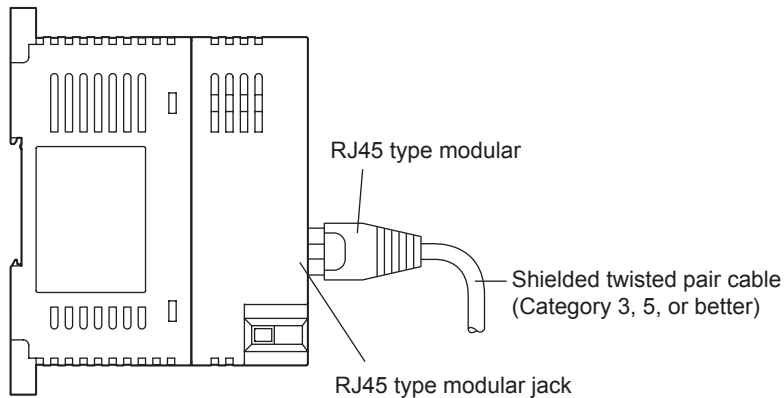

<Operating procedure>

(Step 1) Connect the twisted pair cable to the hub.

(Step 2) Connect the twisted pair cable to the Ethernet adapter.

- 1) The Ethernet adapter detects whether it is 10BASE-T or 100BASE-TX, and in full-duplex or half-duplex transmission mode automatically according to the hub. (Auto detection function)
For connection to a hub without the auto detection function, set the half-duplex mode on the hub side.
- 2) For 10BASE-T or 100BASE-TX connection required devices and a sample system configuration, refer to Section 3.2.

6. Introduction of Functions

6.1 Functions List

This section shows a list of Ethernet adapter functions.

Functions	Description	Reference section
MELSOFT connections	This function allows communication with a MELSOFT product (such as GX Work2) on a LAN (such as company LAN).	Subsection 6.2.1
Communication Using MC Protocol	This function reads/writes the PLC data from/to an external device, and supports subsets of the A-compatible 1E frame.	Chapter 7
MELSOFT Direct Connection (Simple Connection)	This function connects the Ethernet adapter attached to the main unit to a MELSOFT product (such as GX Works2) with one Ethernet cable without using a hub, and enables communication when only the connection destination is specified. It is not necessary to set the IP address.	Subsection 6.2.3
Find CPU function	This function searches (PLC CPUs connected to) Ethernet adapters connected to the same hub as the personal computer using GX Works2, and enables selection of a desired CPU from the list of found CPUs and acquisition of the IP address.	Subsection 6.2.4
Time setting function	This function accesses the time information server (SNTP server) connected to the LAN, collects the time information, and automatically sets the time to the main unit.	Subsection 6.2.5
Parameter setting function	This function sets parameters of the Ethernet adapter from GX Works2 via the main unit.	Subsection 6.2.6
Diagnostics function from MELSOFT	This function diagnoses the Ethernet adapter from GX Works2 via the main unit. (Ethernet Diagnostics)	Subsection 6.2.7

6.2 Details of functions

6.2.1 MELSOFT connections

This function allows communication with a MELSOFT product (such as GX Work2) in the LAN (such as company LAN).

This function is equivalent to the communication function supported on the RS-422 port in the PLC main unit, and provides the following:

- Reading, writing (including writing during RUN) and verification of programs
- Reading and test of devices in the PLC main unit (including buffer memories in special function blocks)

This function is activated when the open method of the connection No. used for the open setting is set to "MELSOFT connections".

For operation of GX Works2, refer to Section 8.2.

6.2.2 Communication Using MC Protocol

For details of MC Protocol, refer to Chapter 7.

6.2.3 MELSOFT Direct Connection (Simple Connection)

This function connects the Ethernet adapter attached to the main unit to a MELSOFT product (such as GX Works2) with one Ethernet cable without using the hub.

The direct connection enables communication by only specifying the connection target. IP address setting is not required.

For direct connection operation of GX Works2, refer to Section 8.5.1.

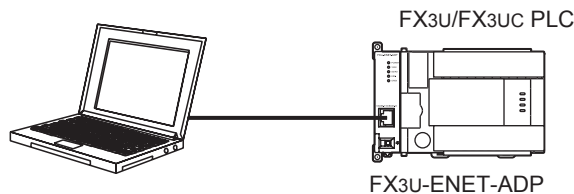

Caution

- When the item "Disable direct connection to MELSOFT" is checked in the Ethernet adapter setting, direct connection is disabled. Check this item to prevent illegal connections from remote places.
- When the Ethernet adapter is connected to the LAN line, do not set direct connection. It may increase the load on the line and adversely affect communication or other devices.
- Do not configure direct connection in a system configuration that connects the Ethernet adapter with an external device using a hub.
- When two or more Ethernet ports are enabled in the network connections setting on the personal computer, communication by direct connection is not possible. In the setting, leave only one Ethernet port enabled for direct connection and disable the other Ethernet ports.
- Under the following conditions, direct connection communication may not be available. In that case, check the setting of the Ethernet adapter, main unit and/or personal computer.
 - When all bits corresponding to "0" of the subnet mask in the personal computer are ON or OFF
 - When all bits corresponding to the host address in each class of IP address in the personal computer are ON or OFF

6.2.4 Find CPU function

This function searches Ethernet adapters (connected to PLC main units) connected to the same hub as the personal computer using GX Works2, and enables selection of a desired Ethernet adapter (PLC main unit) from the list of found Ethernet adapters (PLC main units) and acquisition of the IP address.

For operation of GX Works2, refer to Section 8.5.2.

Caution

- When the item "Do not respond to search for CPU on network" is checked in the Ethernet adapter setting, the Ethernet adapter does not respond to search for CPU on the network.
- Ethernet adapter (PLC main unit CPU) connected to a cascade connected hub are also found and displayed in the list.
- Ethernet adapter (PLC main unit CPU) connected via a router cannot be found.
- If Ethernet adapter (PLC main unit CPU) with the same IP address are found in the list, correct the parameter settings of the Ethernet adapter side IP address. If communication is performed in this situation, a communication error occurs.
- Search for CPU may be disabled when the scan time in the main unit is long. In such a case, make the response waiting time longer on the search for CPU screen.
- When "*****" is displayed as the comment, the keyword setting in the main unit is set to "Read and write prohibited" or "All online operations prohibited".

1

Introduction

2

Specification

3

System Configuration

4

Installation

5

Wiring

6

Introduction of Functions

7

Communication Using M/C Protocol

8

The Operation of GX Works2

9

Troubleshooting

A

List of Special Devices

6.2.5 Time setting function

The Ethernet adapter collects time information from a time information server connected to LAN (SNTP server), making it possible to set the PLC main unit time automatically.

The time setting function queries the time information server to ask the time at the specified timing.

Also, it sets the time sent from the time information server as clock data of the main unit.

The time setting operation is executed based on the following timing.

- At PLC main unit power ON.
- Execution at a specified time interval (Execution interval)
- Execution at a specified time (Execution time)
- At special auxiliary relay ON.*1

*1. The time setting function is valid when the special M bit (CH1: M8411, CH2: M8431) is ON. For details of the special M bit, refer to Appendix A.

For operation of GX Works2, refer to Section 8.3.

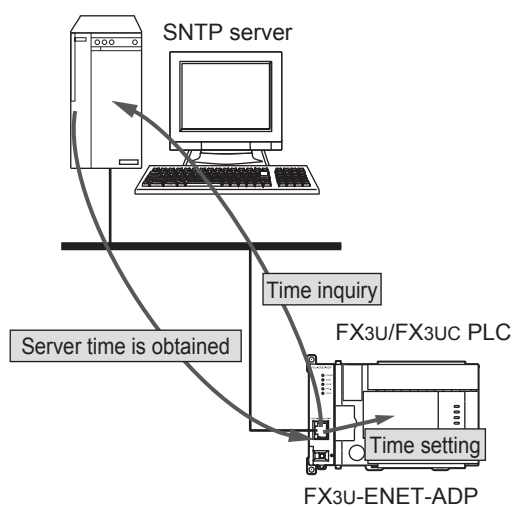

Time setting function settings

Setting	Description
SNTP Function Setting	Select whether or not to use the time setting function.
SNTP Server IP Address*2	Specify the SNTP server IP address.
Time Zone	Specify the time zone (GMT-12:00 to GMT+13:00) in which the time is to be synchronized.
Execute time setting at turn ON	Select whether or not to execute the time setting function when the PLC main unit is powered ON.
On-error Action	Select whether to stop or continue when a time setting error occurs when the PLC main unit is powered ON.
Execution Interval*3	Select to execute the time setting function at a specified time interval. (1 to 1440 min)
Execution Time*3	Select to execute the time setting function at a specified time. (in increments of 30 minutes)
Port No.	123 fixed value

*2. Set the SNTP server IP address after consulting a network administrator (the person who plans the network and manages IP addresses).

*3. One of the two options must be selected.

Caution

- Do not turn ON M8015 (Clock stop and clock setting) in the PLC main unit while the time setting function is used. Turning ON M8015 may cause errors in the Ethernet adapter.
- Do not set the time to the PLC main unit from peripheral equipment while the time setting function is used. Setting the time may cause errors in the Ethernet adapter.
- To use the time setting function, an SNTP server (time information server) is required on the LAN.
- A delay occurs with respect to the time as a result of the time required for communication with the SNTP server.
Specify the closest personal computer for the SNTP server on the network.
- Communication timeout occurs 20 seconds after the time is inquired from the SNTP server (time information server).
- If the power supply of the PLC is turned on in the RUN state when "Execute time setting at turn ON" is set up, the RUN process and time setting will start simultaneously. If "Stop" is set up at "On-error Action", after the PLC RUNs and executes sequence processing upon power ON, it may stop due to time setting error. To avoid this, do not execute sequence processing until time setting has finished. Please refer to the following example program.

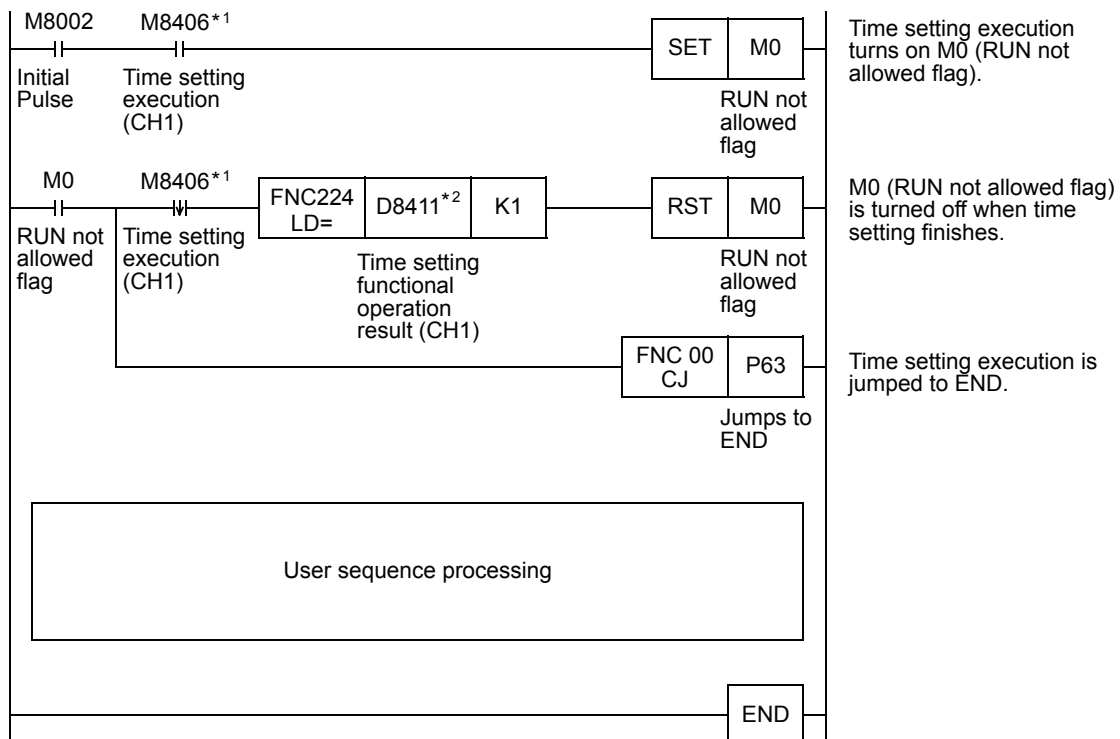
Example program (In case of CH1)

*1. In case of channel 2, set to M8426.

*2. In case of channel 2, set to D8431.

6.2.6 Parameter setting function

This function sets parameters of the Ethernet adapter from GX Works2 via the PLC main unit. For details of operation setting, refer to Section 6.6. For details of open setting, refer to Section 6.11. For operation of GX Works2, refer to Section 8.1 and Section 8.2.

List of parameter setting function settings

Setting	
Channel	
Operation setting	IP address
	Subnet mask pattern
	Default router IP address
	Communication data code
	Direct connection (simple connection)
Open setting	Find CPU function
	Protocol
	Open system
	Host station port No.
	Destination IP Address
	Destination Port No.

6.2.7 The diagnostics function from MELSOFT

This function diagnoses the Ethernet adapter from GX Works2 via the PLC main unit. (Ethernet Diagnostics) For operation of GX Works2, refer to Section 8.6.

The diagnostics function list from MELSOFT

function	Description
Parameter status	IP address, Ethernet address, etc. are displayed.
Error history ^{*1}	Connection No., error code, port number, date, time, etc. are displayed.
Status of each connection	Host station port No., Destination IP Address, Destination Port No., newest error code, etc. are displayed.
Access history ^{*1}	The date, time, connection No., Destination IP Address, etc. are displayed.
Status of each protocol	TCP packet, UDP packet, etc. are displayed.
Connection status	Full-duplex/Half-duplex, connection condition, and 10BASE-T/100BASE-TX are displayed.
Time setting status ^{*1}	The latest time setting time and the Acknowledge duration are displayed.
PING test	This test checks the presence of Ethernet module in the Ethernet line in which initialization is completed or the presence of specified IP address.

*1. Log record setting is required in advance. For details of setting, refer to Section 8.4.

Caution

The diagnostics function is available even if the PLC main unit is set to batteryless mode, but the diagnostic result is cleared when the power is turned OFF once and ON again.

6.3 Setting Items List

The table below shows parameter settings set in the Ethernet adapter.

Setting	Description	Necessity of parameter setting		Reference section
		MC protocol	MELSOFT	
Channel	Select whether or not the Ethernet adapter is connected. When the Ethernet adapter is connected, select the channel (CH).	✓	✓	Section 8.1
Operation setting	Set the common items in the Ethernet adapter.	✓	✓	Section 6.6, Section 8.1
Open setting	Set the connection opening processing required to transfer data with the external device.	✓	✓	Section 6.11, Section 8.2

✓ : Setting is required when applicable function is used ✕ : Setting not required

6.4 Settings and Procedures Prior to Starting the Operation

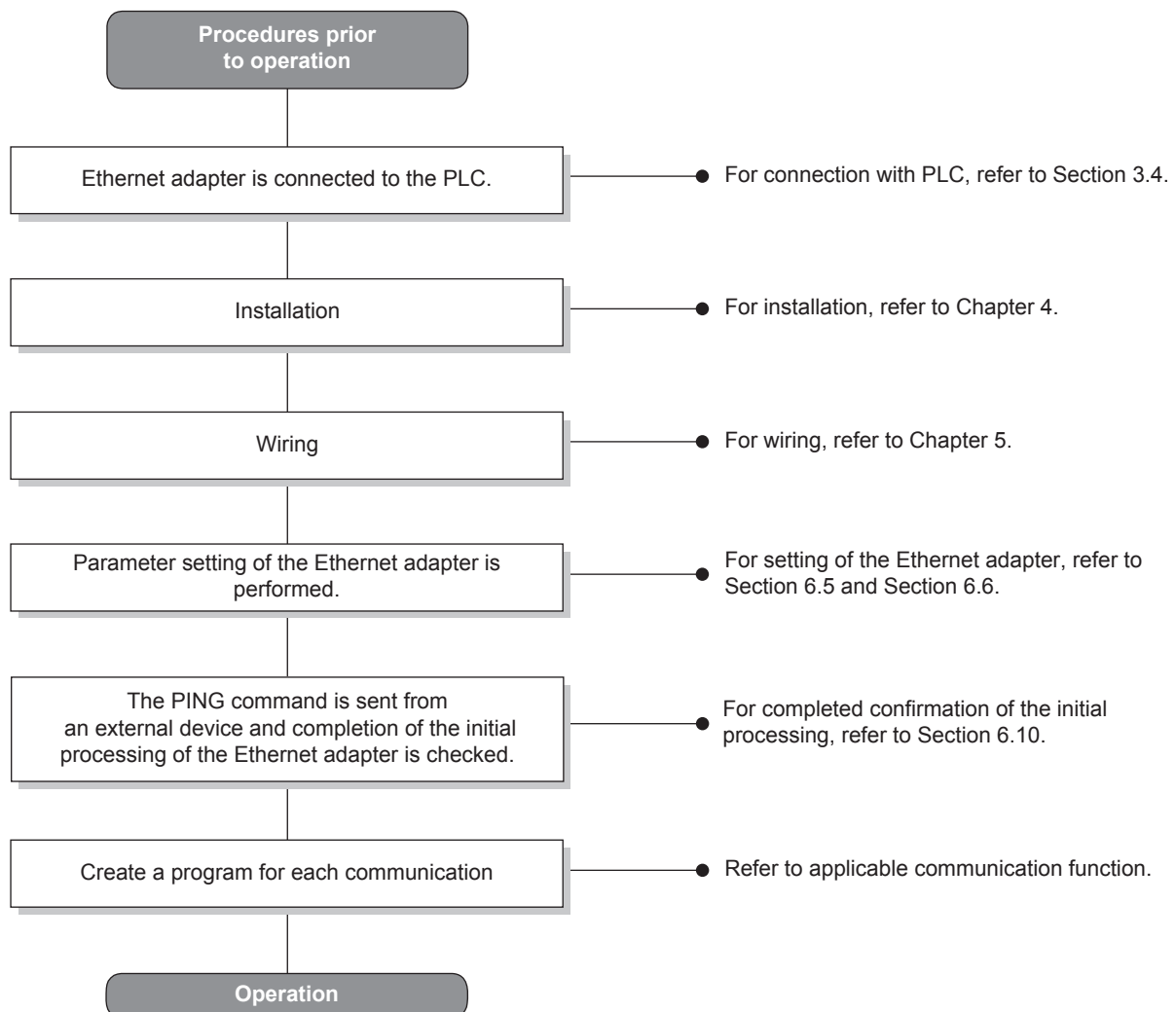

Caution

- When the parameter setting is added or changed in GX Works2, the contents of addition or change are not reflected automatically.
After writing parameters of the Ethernet adapter, turn OFF the power of the Ethernet adapter (PLC), and turn it ON again.
- When the Ethernet adapter is replaced, reboot the external device as well. (If the external device retains the Ethernet address, it may be impossible to continue communication because when an adapter is replaced the Ethernet address changes.)
Similarly, when the external device (personal computer, etc.) is replaced, reboot the Ethernet adapter.

6.5 Ethernet adapter Setting

Setting the Ethernet adapter as a network adapter.

The settings below must always be set in order to use the Ethernet adapter.

- 1) "Operation setting" (Detailed explanation : Section 6.6)
Set the common items in the Ethernet adapter required to use the Ethernet adapter.
Make sure to execute this setting because it is required to initialize the Ethernet adapter.
- 2) "Open setting" (Detailed explanation : Section 6.11)
Set the connection opening processing and MC protocol application required to transfer data with the external device.

The settings of the Ethernet adapter are written as special parameters to the PLC main unit.

Special parameters are parameters for special adapters and special blocks connected to the PLC main unit.

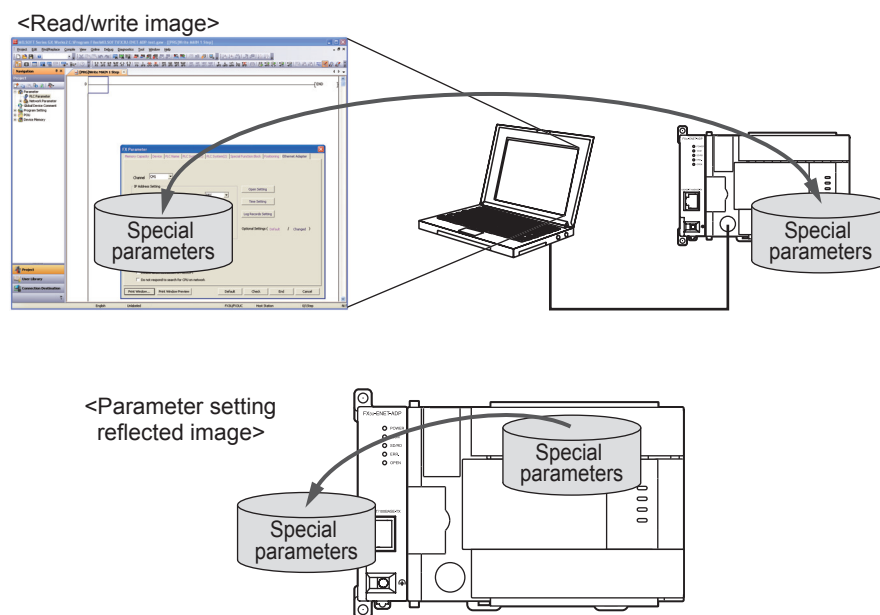
**Caution**

When special parameters of the Ethernet adapter are set to communication channel 1 (or 2), the communication setting from D8120, D8400 (or D8420) becomes invalid.

6.6 Operational Settings

For operation of GX Works2, refer to Section 8.1.

List of operation setting

	Setting	Description
Operation setting	IP address	Set the Ethernet adapter IP address.
	Subnet mask pattern	Set the subnet mask pattern.
	Default router IP address	Set the default router IP address.
	Communication data code	Select a communication data code used for MC protocol, "Binary code" or "ASCII code".
	Direct connection (simple connection)	Select whether or not direct connection (simple connection) is used.
	Find CPU function	Select whether or not the find CPU function is used.

1) IP Address settings

Set the IP address of the local station according to the specified input format (decimal or hexadecimal).

Setting range : 0.0.0.1 to 223.255.255.254 (decimal)

00.00.00.01 to DF.FF.FF.FE (hexadecimal)

It should be set so that the local station Ethernet adapter and the communicating external device have the same class and subnet address.

Set the IP address after consulting a network administrator (the person who plans the network and manages IP addresses).

2) Subnet mask pattern settings^{*1}

Set the subnet mask pattern of the local station according to the specified input format (decimal or hexadecimal).

Setting range : 192.0.0.0 to 255.255.255.252 (decimal)

C0.00.00.00 to FF.FF.FF.FC (hexadecimal)

Set the subnet mask pattern after consulting a network administrator (the person who plans the network and manages IP addresses).

When not using the subnet mask, set any of the following table values according to class.

Class	Mask value	
	Decimal	Hexadecimal
Class A	255.0.0.0	FF.00.00.00
Class B	255.255.0.0	FF.FF.00.00
Class C	255.255.255.0	FF.FF.FF.00

*1. Ethernet networks include small-scaled network systems where multiple devices are connected to one Ethernet hub along with medium and large-scaled network systems where multiple small-scaled networks are connected by routers, etc.

The subnet mask logically divides one network, where many devices are connected, into multiple sub-networks to facilitate administration.

Caution

All devices on the same sub-network must have a common subnet mask.

3) Default router IP address settings

Set the IP address of the router to be used when the Ethernet adapter communicates with the target device on another Ethernet network.

Set the value that satisfies the following conditions.

- Condition 1: The IP address class is either A, B or C.
- Condition 2: The subnet address of the default router is the same as that of the local station Ethernet adapter.
- Condition 3: The host address bits are not all "0" or all "1".

Set the default router IP address after consulting a network administrator (the person who plans the network and manages IP addresses).

- 4) Communication data code settings
Select the format of the communication data (MC Protocol) when communicating with an external device.

Name of setting	Description of setting
Binary code	Communicate using binary code data.
ASCII code	Communicate using ASCII code data.

When communicating using ASCII code, 1-byte binary code data is automatically converted into 2-byte ASCII code data and then transmitted.

(Example)

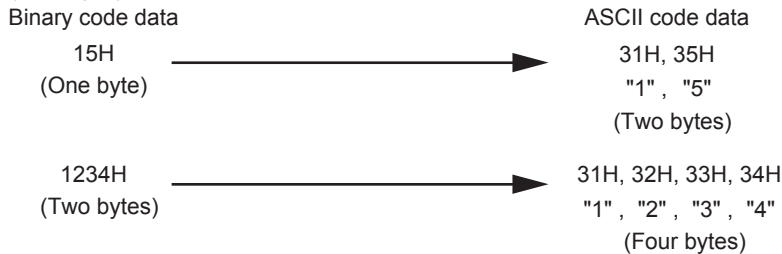

- 5) Direct connection (simple connection) settings
Select whether or not direct connection (simple connection) is used.
For operation of GX Works2, refer to Section 8.1. For other contents, refer to Subsection 6.2.3.
- 6) Find CPU function settings
Select whether or not the find CPU function is used.
For operation of GX Works2, refer to Subsection 8.5.2. For other contents, refer to Subsection 6.2.4.

6.7 Overview of the Communication Procedure

This section gives an overview of the procedure for performing data communication with external devices via the Ethernet adapter.

Start data communication by establishing connections with external devices via initial and open processing.
End data communication by closing the connection, and, as a result, terminating all communication processing.

The following diagram illustrates the communication procedure:

(There is no connection since UDP/IP does not have a notion of connection.)

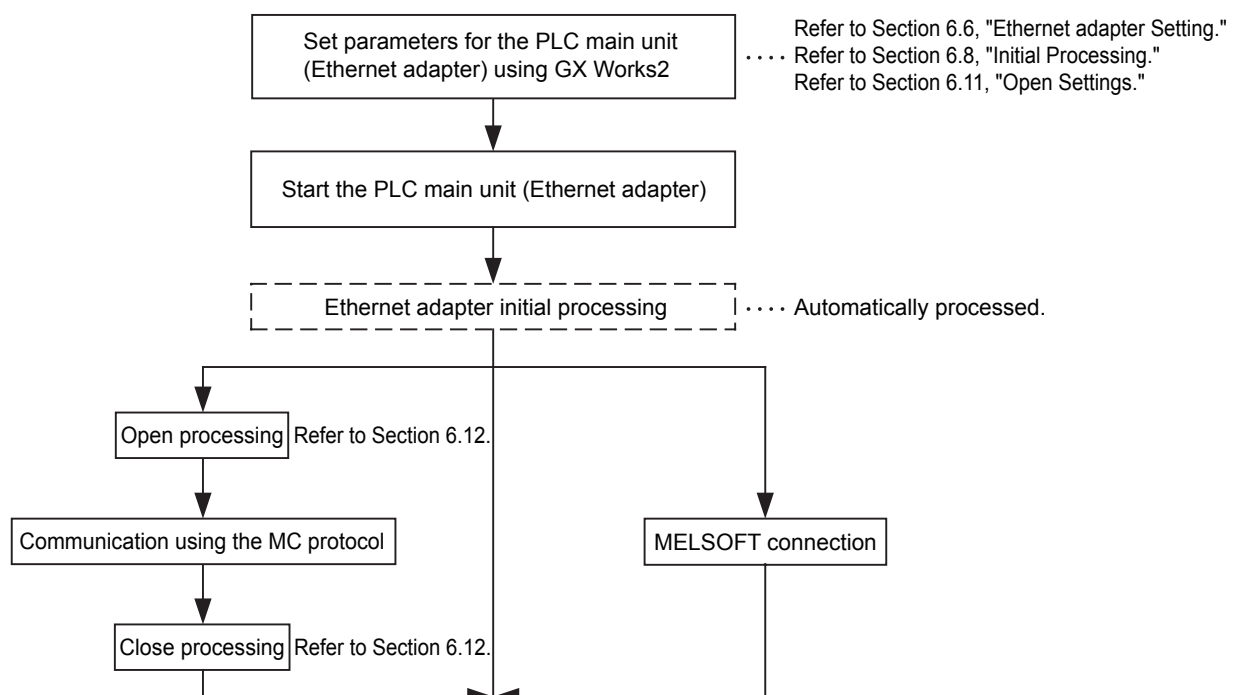

6.8 Initial Processing

This section explains the initial processing of the Ethernet adapter.

6.8.1 Initial processing

Initial processing enables data communication with an external device by setting the parameters required for data communication via the Ethernet adapter.

The Ethernet adapter automatically executes initial processing based on parameters set in GX Works2.

When parameters are set in GX Works2 and then the power of the Ethernet adapter (PLC) is turned OFF and ON, initial processing is executed.

6.8.2 Initial settings

The Ethernet adapter automatically executes initial processing based on parameters set in GX Works2. You do not have to write the initial settings.

6.8.3 Re-initialization

Re-initialization (which sets the Ethernet adapter to the status at startup without turning OFF and ON the power of the PLC) is not available in the Ethernet adapter.

After setting parameters in GX Works2, turn OFF and ON the power of the Ethernet adapter (PLC).

6.9 Router Relay Parameter

Ethernet adapter access from the company LAN, etc. via a router are enabled when the subnet mask pattern and default router IP address are set in the operation setting.

6.10 Confirming Completion of Initial Processing

The initial processing of the Ethernet adapter is completed when the power of the PLC main unit is turned OFF and ON after parameters are written to the PLC main unit.

This section explains how to check for completion of initial processing.

Caution

Ethernet adapter communication is enabled when initial processing is completed normally. See reference sections for each communication function to work.

When initial processing has not been completed normally, do the following: check the error contents, take corrective actions, then execute the initial processing again.

- Check the error code using the "Parameter status" of Ethernet diagnostics. (Refer to Section 8.6 and Subsection 9.2.1.)
- Check the contents of the error corresponding to the error code, then take corrective actions. (Refer to Subsection 9.3.1.)

6.10.1 PING command (Personal computer -> Ethernet adapter)

For PING command operation of GX Works2, refer to Subsection 8.6.7.

The following example illustrates how to confirm completion of initial processing by issuing the PING command to the local station's Ethernet adapter from an external device (personal computer) connected on the same Ethernet network. (In the example, the confirmation is made between devices whose IP address class and subnet address are identical.)

<Designation method>

ping IP address

<Example>

IP address of the Ethernet adapter: 192.0.1.254

Example of screen at normal completion

```
C:\>ping 192.0.1.254 Execute the ping command
Pinging 192.0.1.254 with 32 bytes of data:
Reply from 192.0.1.254: bytes=32 time=1ms TTL=64
Reply from 192.0.1.254: bytes=32 time<10ms TTL=64
Reply from 192.0.1.254: bytes=32 time<10ms TTL=64
Reply from 192.0.1.254: bytes=32 time<10ms TTL=64
Ping statistics for 192.0.1.254:
Packets: Sent = 4, Received = 4, Lost = 0 (0% loss)
Approximate round trip times in milli-seconds:
Minimum = 0ms, Maximum = 1ms, Average = 0ms
C:\>_
```

Example of screen at abnormal completion

```
C:\>ping 192.0.1.254 Execute the ping command
Pinging 192.0.1.254 with 32 bytes of data:
Request timed out:
Request timed out:
Request timed out:
Request timed out:
Ping statistics for 192.0.1.254:
Packets: Sent = 4, Received = 0, Lost = 4 (100% loss)
Approximate round trip times in milli-seconds:
Minimum = 0ms, Maximum = 0ms, Average = 0ms
C:\>_
```

<When the PING command does not respond successfully>

Check the following items and send the PING command again.

- Check the Ethernet adapter connection.
- Check the connection to the Ethernet network.
- Check the contents of each parameter written to the Ethernet adapter.
- Check the operation condition of the Ethernet adapter (are there any irregularities?).
- Check the IP address of the Ethernet adapter dictated by the PING command.

6.10.2 Loop back test (Communication using MC protocol)

The loop back test can be performed with communication using MC protocol in order to check the completion status of initial processing for the target Ethernet adapter.
The following is an overview of the loop back test for communication using MC protocol.
For details, refer to Section 7.7.

- 1) Loop back test for communication using MC protocol
The loop back test is a function designed to check the following:
 - Whether a line has been properly connected to the test target Ethernet adapter.
 - Whether the parameters for the Ethernet adapter have been correctly set.
 - Whether the initial processing for the Ethernet adapter has been completed normally.
 - Whether the program for the external device is running correctly.
- 2) It is necessary to connect lines when performing communication using MC protocol with the user port on the Ethernet adapter side.
Perform open processing for the connection to be used on the Ethernet adapter side.
- 3) This function can only be used for the Ethernet adapter of the local station. The function cannot be used for the Ethernet adapter of another station via a network system.

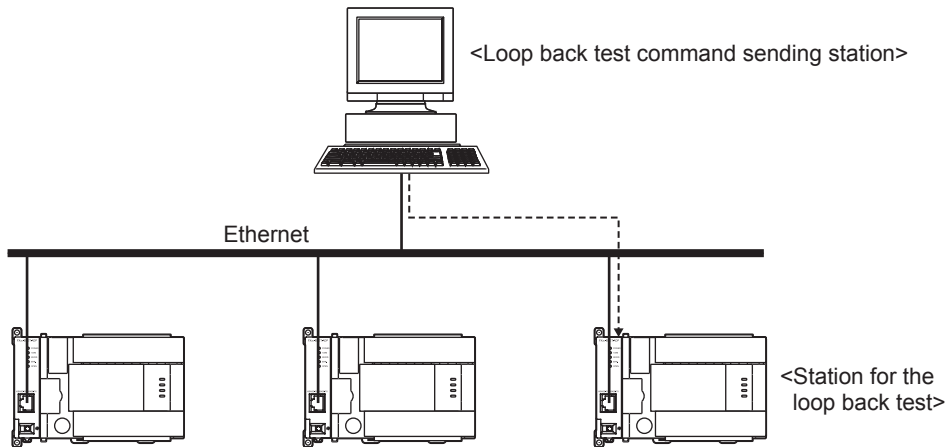

6.11 Open Settings

This section explains open settings.
Open settings operation (establishing connection) with the external device can be performed to a maximum of four stations.
Once a connection is established with an external device, it is possible to communicate using MELSOFT connections and MC protocol.
For open settings operation of GX Works2, refer to Section 8.2.

Open settings

Setting	Description
Protocol	Choose from TCP/UDP.
Open system	Choose from the following. • MELSOFT connection (TCP only) • MC protocol (TCP/UDP)
Host station port No.	Set host station port No. Range: 1025 to 5548 or 5560 to 65534
Destination IP Address	Set destination IP address. Required only when using MC protocol (UDP).
Destination Port No.	Set destination port No. Range: 1025 to 65534 Required only when using MC protocol (UDP).

- 1 Introduction
- 2 Specification
- 3 System Configuration
- 4 Installation
- 5 Wiring
- 6 Introduction of Functions
- 7 Communication Using MC Protocol
- 8 The Operation of GX Works2
- 9 Troubleshooting
- A List of Special Devices

- 1) Protocol
 Select the protocol (communication method) for each connection between "TCP" and "UDP" in accordance with the external device.
 Select "TCP" when placing importance on the reliability of communication.

Name of setting	Description of setting
TCP	Communicate using TCP/IP.
UDP	Communicate using UDP/IP.

For explanation of TCP/UDP, refer to Subsection 1.1.3.

- 2) Open system
 Select the connection open system for each connection for which "TCP" is selected in "1) Protocol".
 If "UDP" is selected, this specification is not required. (MC protocol anchoring)

Name of setting	Description of setting
MELSOFT connections	Connection is opened by MELSOFT connection.
MC Protocol	Connection is opened by MC Protocol.

- 3) Host station port No.
 In this item the port number of each connection for the Ethernet adapter is set. Required only when using MC protocol (TCP/UDP).
 Setting range
 MC protocol : 1025 to 5548, 5552 to 65534
 Set port numbers that are not already used by other ports.
 Set the port numbers for the Ethernet adapter upon consulting a network administrator.
- 4) Destination IP Address
 Set the IP address of the communication counterpart (external device) for each connection of the Ethernet adapter (2 words).
 Required only when using MC protocol (UDP).
 The IP addresses of external devices must be given values other than 0.0.0.0 (00.00.00.00H), 255.255.255.255 (FF.FF.FF.FFH).
 Set the IP addresses of external devices upon consulting a network administrator.
- 5) Destination Port No.
 Set the port number of the communication counterpart (external device) for each connection of the Ethernet adapter.
 Required only when using MC protocol (UDP).
 The port numbers of the external devices are set in the range from 1025 to 65534.
 Set the port numbers for the external device upon consulting a network administrator.

6.12 Open Processing/Close Processing of the Connection

This section explains the open processing/close processing of a connection.
 For open settings operation of GX Works2, refer to Section 8.2.

- 1) Open processing
 The purpose of open processing is to establish a connection with an external device in order to perform the following forms of data communication.
 They can be performed with an external device opened by the user.
- MELSOFT connection (TCP only)
 - MC protocol (TCP/UDP)

2) Close processing

The purpose of close processing is to disconnect (cancel) the connection with the external device established by open processing mentioned previously.

Close processing is used when terminating a connection with an external device, changing an external device of a connection, changing communication conditions, etc.

Perform close processing for connections established by open processing using sequence programs.

Determine the timing of close processing with the external device.

The Ethernet automatically closes the connection in the following cases even if a request for closing is not given.

a) When the existence confirmation function times out.

b) When a close or RST command is received from an external device.

c) When an active open request is received again from an external device in the open completion status of TCP.

After returning ACK to the external device, the Ethernet adapter closes the connection when the RST command is received from the external device.

However, when receiving an active open request again from an external device with a different IP address or port No., the Ethernet adapter only sends the RST command. (It does not close the connection.)

MEMO

7. Communication Using MC Protocol

This chapter gives an overview of the MC protocol.

The frame type of MC protocol (data communication messages) used by the external device to access the PLC via this product is equivalent to A compatible 1E frame.

(Example)

Header			Subheader	Text (Command)									
Ethernet (14bytes)	IP (20bytes)	TCP / UDP		PC No.	ACPU monitoring timer		Head device		Number of device points				
			00H	FFH	L 0AH	H 00H	L	-			-	-	H

(Command message for A compatible 1E frame)

7.1 Data Codes for Communication

This section explains the data codes used in communication between the Ethernet adapter and the external device or the PLC.

- 1) The data codes used while communicating are listed below.
 - a) Ethernet adapter ↔ External device
 You can execute data communication by selecting "binary code" or "ASCII code" in GX Works2.
 To switch between binary code/ASCII code, refer to Section 6.6.
- 2) When communicating using ASCII code, 1-byte binary code data is automatically converted into 2-byte ASCII code data and then transmitted.

(Example)

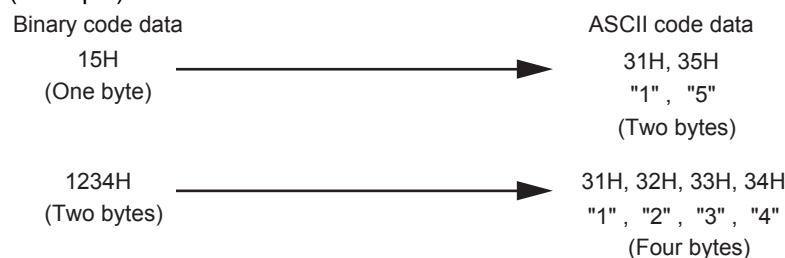

7.2 Data Communication Function

The MC protocol is the abbreviated name of the MELSEC protocol that is a communication system for the PLCs. Using this protocol, the external devices can read or write device data from/to the PLC via the Ethernet adapter.

Any external devices on which application programs can be installed and which can send and receive data in accordance with the MELSEC PLC protocol can access the PLC using MC Protocol.

1	Introduction
2	Specification
3	System Configuration
4	Installation
5	Wiring
6	Introduction of Functions
7	Communication Using MC Protocol
8	The Operation of GX Works2
9	Troubleshooting
A	List of Special Devices

7.2.1 Accessing the PLC using MC protocol

This section explains the main functions for accessing the PLC using MC protocol.

On the PLC side, the Ethernet adapter sends and receives data based on instructions (protocol) from external devices, so the PLC side does not require sequence programs for data communication.

1) Data read/write

This function reads/writes data from/to the PLC device memory to which the Ethernet adapter is connected. By reading and writing data, the PLC operation monitoring, data analysis and production management can be performed on the external device side.

2) Remote control of the PLC

This function executes remote RUN/STOP operations.

Remote operations of the PLC can be performed from the external device side.

Function name	Send frame	Communication data code	Function	Description
Communication using MC protocol	A compatible 1E frame	ASCII code or binary code *1	Device memory read/write	Batch read/write in bit/ word units
			Remote control of the PLC	Remote RUN Remote STOP

*1. Time required for communication in binary code is shorter because the amount of communication data is approximately half of what is required for communication in ASCII code data.

7.2.2 How to Read the Control Procedures of the MC Protocol

This section explains the control procedures when an external device accesses the PLC using MC protocol.

1) Transmission of command messages

Data communication through the MC protocol is performed using half-duplex communication.

When accessing the PLC, send the next command message after receiving a response message from the PLC side for the previous command message transmission.

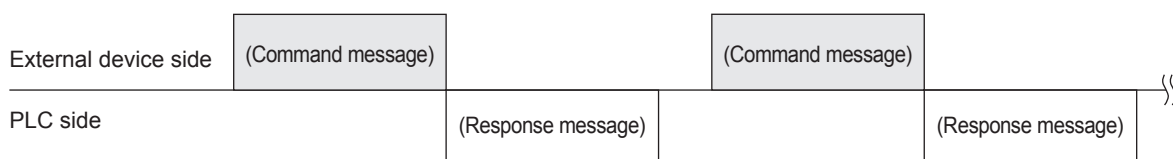

2) When a normal completion response message to a command message cannot be received

a) If an abnormal completion response message is received

Handle the case according to the error code in the response message.

b) If the response message cannot be received or nothing can be received

Send the command message again after a period of time beyond the monitoring time of the response monitor timer has passed.

Modify the value of the monitoring time as needed.

7.2.3 Access Timing on the PLC Side

The following diagram illustrates the access timing on the PLC side when an external device accesses the PLC via the Ethernet adapter.

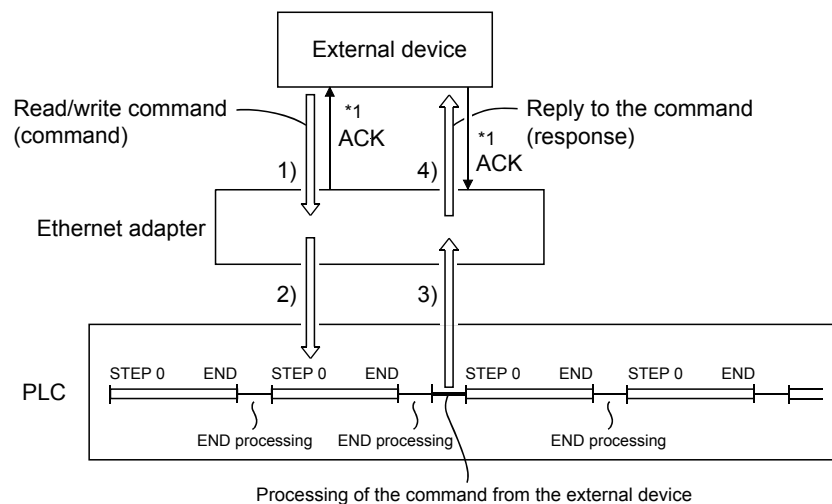

- 1) A command message is transmitted from the external device to the PLC side.
- 2) Upon receiving a command message from the external device, the Ethernet adapter on the PLC side sends a data read/write request to the PLC according to the content of the command.
- 3) The PLC reads/writes data according to the request from the external device at the time of executing the sequence program's END instruction, and passes the processing result to the Ethernet adapter.
- 4) Upon receiving the processing result from the PLC, the Ethernet adapter sends a response message including the processing result to the external device that originated the request.

- *1. The ACK response shown in the diagram is sent/received between the Ethernet adapter and the external device respectively when access via the Ethernet adapter is performed by TCP/IP communication. It is different from the response to the processing requested by the external device in the command message (the processing result).
When access via the Ethernet adapter is performed by UDP/IP, the ACK response indicated by *1 is not sent.

Regarding the scan time of the PLC

- While the PLC is performing a required command, access command to the Ethernet adapter and the PLC is processed during every END processing.
(The scan time becomes longer according to the amount of time it takes to process the command.)
- When multiple external devices issue access requests to the Ethernet adapter at the same time, the processing requested from the external devices may have to wait for multiple END processing executions depending on the timing of the requests.

7.2.4 PLC setting for performing data communication

Set the following contents in GX Works2, write parameters to the main unit, and turn OFF and ON the power of the Ethernet adapter (PLC) to enable data communication using the MC protocol.

- 1) Operational settings (Refer to Section 6.6, Section 8.1)
- 2) Open settings (Refer to Section 6.11, Section 8.2)

7.2.5 Precautions on Data Communication

This section explains some precautions that should be observed when performing data communication between an external device and the Ethernet adapter.

- Reading/writing data when the Ethernet adapter status is as follows
Data communication using the MC protocol from the external device is enabled without regard to the absence/presence of a sequence program when the FX3U-ENET-ADP unit ready signal (M8404 and M8424, refer to Appendix A for details) is ON and the opening completion signal (corresponding bit of D8406 and D8426, refer to Appendix A for details) for the used connection is ON (1: Open).
- Data communication using the MC protocol is enabled only when the open system in the open setting (refer to Section 6.11) is set to "MC protocol". (For operation of GX Works2, refer to Section 8.2.)
- Replacing the Ethernet adapter
The Ethernet address (MAC address) differs depending on the device.
When the Ethernet adapter is replaced due to breakdown, reboot any external devices also.
Similarly, reboot the Ethernet adapter even when an external device is replaced (such as a personal computer).

7.3 Message Formats and Control Procedures

This section explains the message format and control procedure for each command when data communication is performed using A compatible 1E frames.

The MC protocol for the Ethernet adapter is a subset of A compatible 1E frames.

Both TCP/IP and UDP can be used as lower layer protocol and support both ASCII code and binary code.

7.3.1 How to read the command reference section

The following explains how to read the message explanation diagrams shown in each of the command description Section 7.5 through 7.7.

- 1) When an external device reads data from the PLC

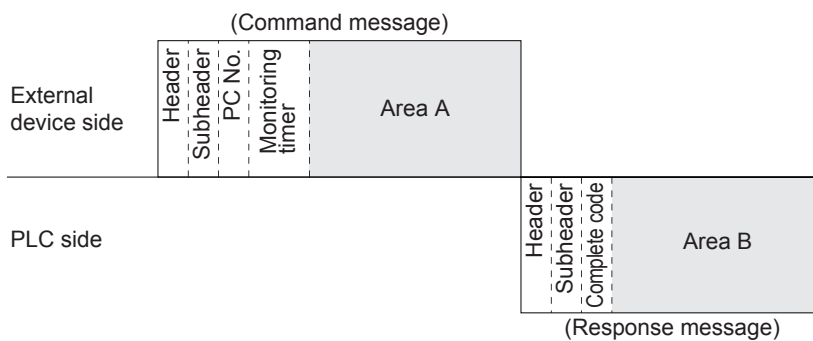

- a) Area A indicates transmission from the external device to the PLC.
- b) Area B indicates transmission from the PLC to the external device.
- c) The program of the external device is generated so that the data is transmitted sequentially from left to right. (For example: in case of area A, data should be sequentially sent starting from the header.)

- 2) When an external device writes data to the PLC

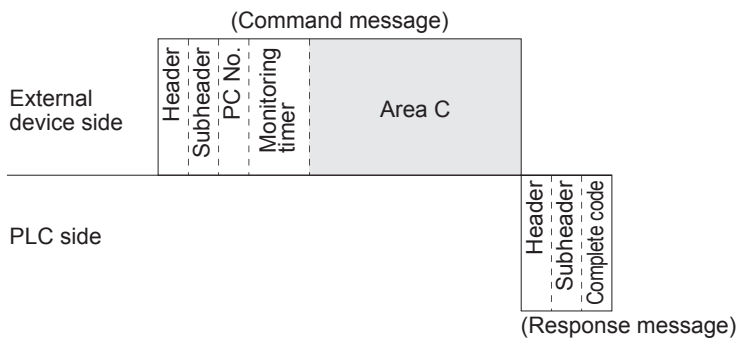

- a) Area C indicates transmission from the external device to the PLC.
 b) The program of the external device is generated so that the data is transmitted sequentially from left to right. (For example: in case of area C, data should be sequentially sent starting from the header.)

When the PLC receives a command message from an external device, it completes processing of the data in area A/C, then sends a response message and waits for the next command message (neutral state).

7.3.2 Message format and control procedure

This section explains the message format and control procedure.

- 1) Message format

This section explains the message format for transmission between the Ethernet adapter and an external device.

The communication data consists of "header" and "application data" as shown below.

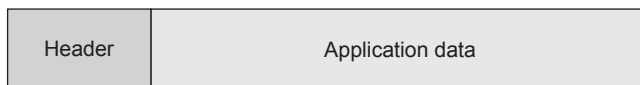

- a) Header

The header for TCP/IP or UDP/IP is used. The user does not need to specify it; the Ethernet adapter attaches it.

- b) Application data

The application data is largely divided into "subheader" and "text" as shown below.

- The subheader represents command/response and the setting value is predetermined.
- The text contains the request data (command) and response data (response) for each function and this data is determined by the prescribed format (for a more detailed description, refer to Section 7.5 and later).

- c) Format in the application data field

- Communication in ASCII code

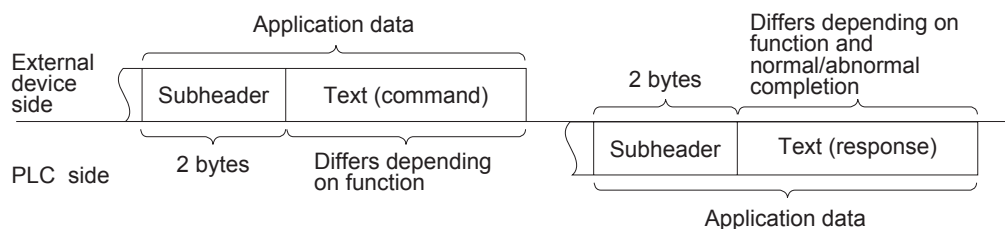

- Communication in binary code

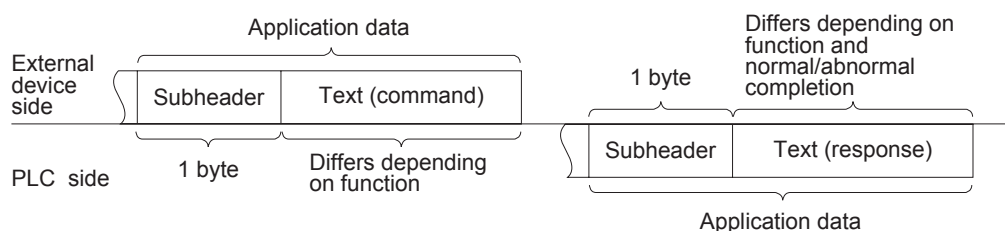

When communicating using the MC protocol, the user does not need to specify a response for a command from an external device; the Ethernet adapter generates it and then responds.

2) Control procedure

The following diagrams illustrate the control procedure for communicating with the MC protocol and the order of data items in the application data field.

The header section shown in the message explanation diagram " * " of this section corresponds to the portion of the message explanation diagrams indicated in Subsection 7.5.2 and later.

Refer to Subsection 7.3.3 regarding the content of data items in the message format and data specification method.

a) Communication in ASCII code

- When reading data from the local station PLC at the external device side

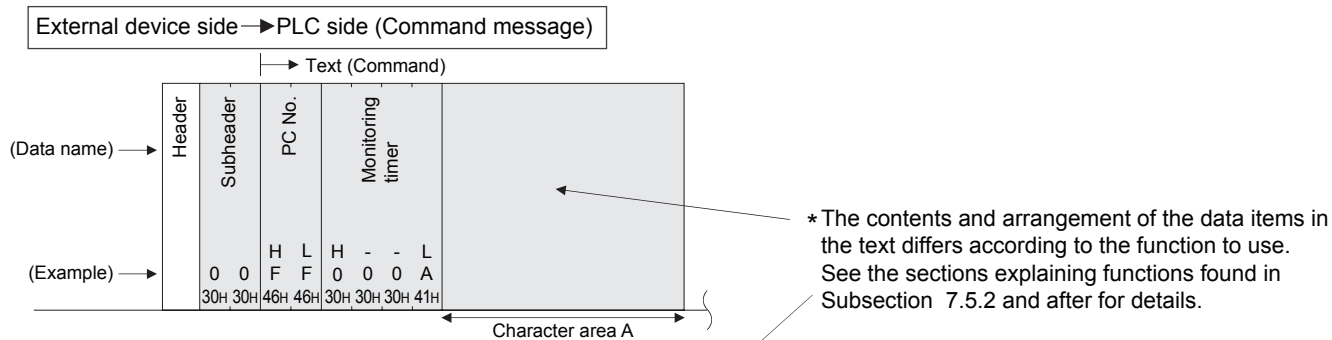

PLC side → External device side (Response message)

(Normal completion)

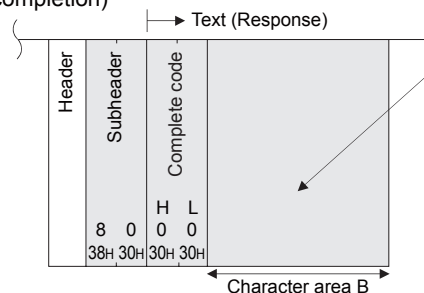

(Abnormal completion)

(When complete code 5BH is returned)

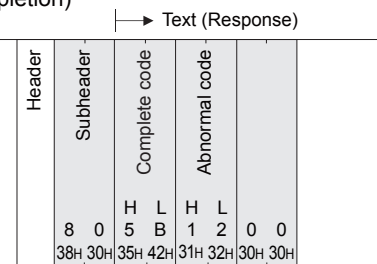

- When writing data to the local station PLC from the external device side

External device side → PLC side (Command message)

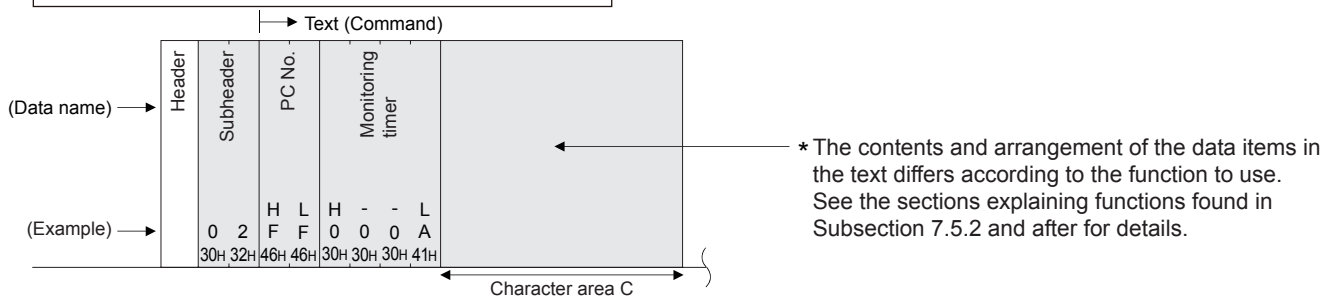

PLC side → External device side (Response message)

(Normal completion)

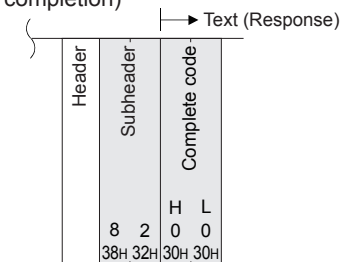

(Abnormal completion)

(When complete code 5BH is returned)

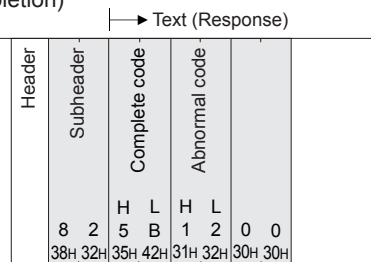

b) Communication in binary code

- When reading data from the local station PLC at the external device side

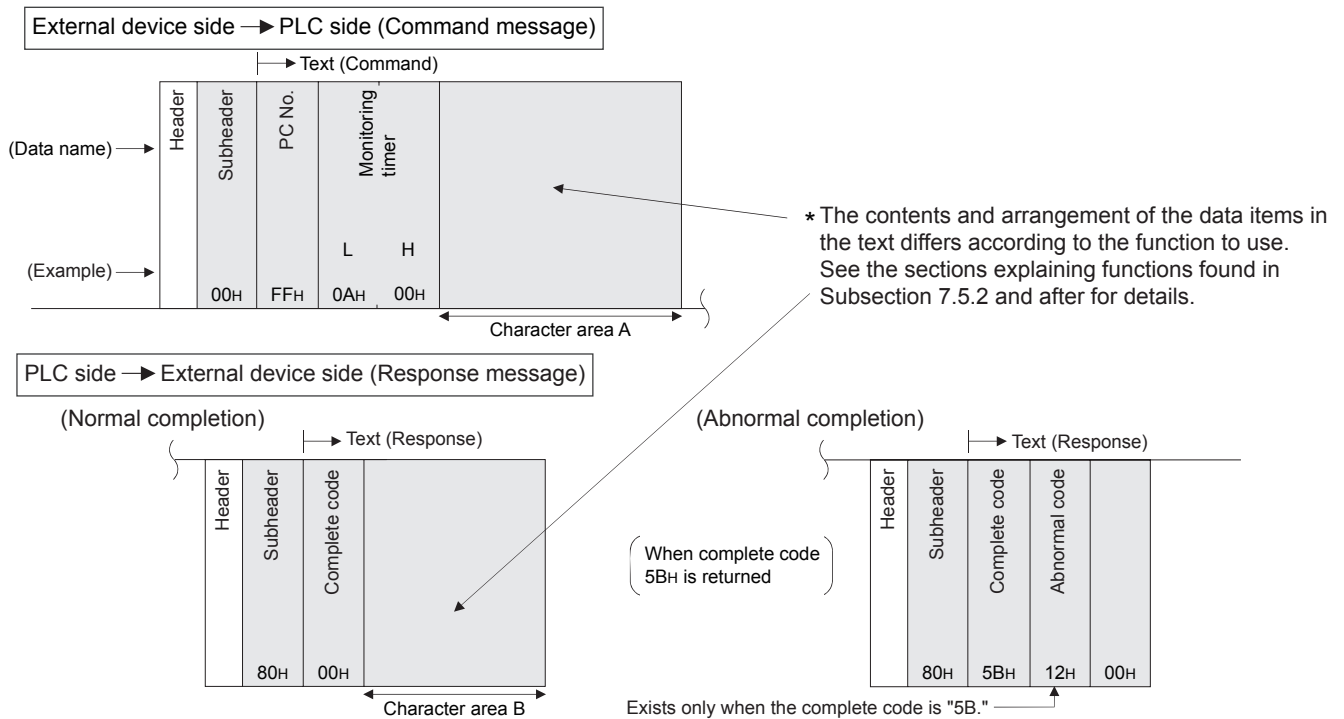

- When writing data to the local station PLC from the external device side

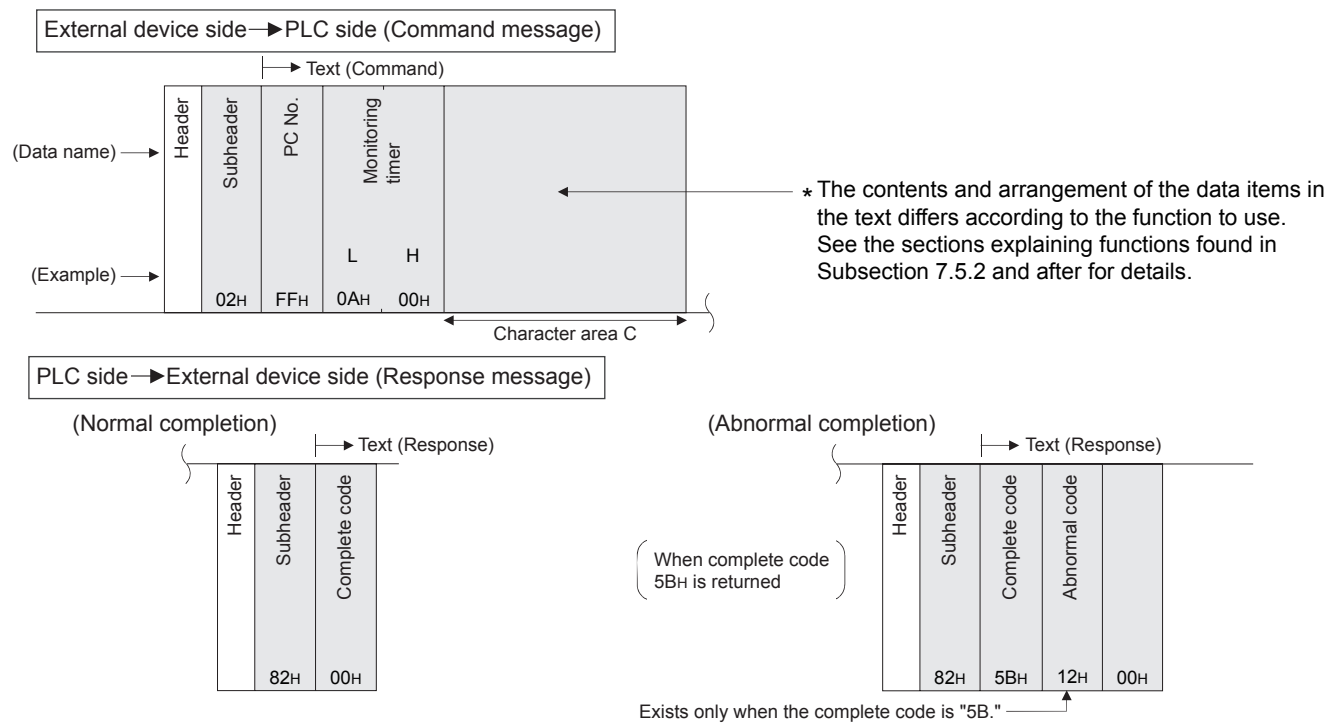

1	Introduction
2	Specification
3	System Configuration
4	Installation
5	Wiring
6	Introduction of Functions
7	Communication Using MC Protocol
8	The Operation of GX Works2
9	Troubleshooting
A	List of Special Devices

7.3.3 Contents of data designation items

This section explains the data items of commands and responses when communicating using MC protocol. In the response that is returned by the Ethernet adapter to an external device, the data is automatically specified by the Ethernet adapter; the user does not need to specify it.

1) Header
The header for TCP/IP or UDP/IP is used. The user does not need to specify it at the PLC side; the Ethernet adapter attaches it.

2) Subheader
The format of the subheader is configured as follows.

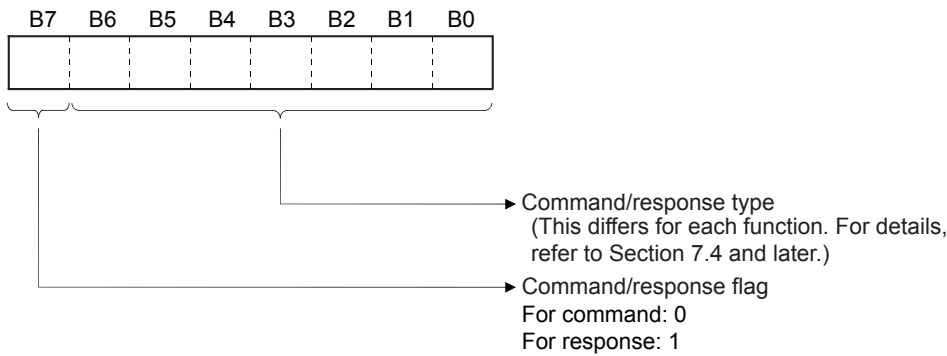

- 3) PC number
The PC number is fixed at a value of "FFH".
a) When communicating in binary code, the PC number is expressed in binary value.
b) When communicating in ASCII code, the PC number is expressed in hexadecimal ASCII code.
- 4) Monitoring timer
This is a timer for setting the period of time that the Ethernet adapter should wait after outputting a read/write request to the PLC until the result is returned.
a) Specify the value as shown below.
0000H (0) : Waits infinitely (It keeps waiting until a response is returned from the PLC.)
0001 to FFFFH (1 to 65535) : Wait time (in units of 250 ms)
b) For normal data communications, using a value within the setting range of 1 to 40 (0.25 to 10s) is recommended.
- 5) Character area (command)
This data contains the Ethernet adapter commands that indicate functions for when an external device reads/writes data from/to the target PLC station. The contents and order of data in the character area (command) field differ depending on the function used. The order of data items for each function is explained in each function's reference section in Subsection 7.5.2 and later.
- 6) Character area (response)
This data contains data read/processing result when an external device reads/writes data from/to the target PLC station. The contents and order of data in the character area (response) differ depending on the function used. The order of data items at normal completion for each function is explained in each function's reference section in Subsection 7.5.2 and later.

7) Complete code

The result of processing when an external device reads/writes data from/to the target PLC station is indicated by the following values.

00H : Normal completion
Other than 00H : Abnormal completion (50 to 60H)

- a) When communicating in binary code, the complete code is expressed in binary values.
- b) When communicating in ASCII code, the complete code is expressed in hexadecimal ASCII code.
- c) When the complete code indicates abnormal completion, check the content and take action according to the troubleshooting section of Chapter 9.
When the complete code is 5BH/"5B," the abnormal code data (10 to 18H) and 00H/"00" are included immediately after.

8) Abnormal code

This value indicates the nature of the error when the processing result of reading/writing data from/to the target PLC station by an external device is faulty and the complete code is 5BH/"5B." (Abnormal code: 10 to 18H)

- a) When communicating in binary code, the abnormal code is expressed in binary values.
- b) When communicating in ASCII code, the abnormal code is expressed in hexadecimal ASCII code.
- c) Check the content and take action according to the troubleshooting section of Chapter 9.

Caution

The data code (ASCII/binary) when sending/receiving commands and responses between the Ethernet adapter and an external device is determined in the operation settings in GX Works2.

The external device communicating with Ethernet adapter should send the values specified in each data item in the commands and responses in the above setting using the code shown below. Also, it should receive the corresponding values in the code shown below.

In the explanation hereafter in this section, the values specified in each item in a command and response are shown in binary values.

- 1) Communication in binary code
Unless specifically stated, the value shown in each explanation is sent/received in the designated order (L to H) since it is in binary.
- 2) Communication in ASCII code
Unless specifically stated, the value shown in each explanation is converted to hexadecimal ASCII code and sent/received in the designated order (H to L).

<Note>

The following example shows the designation of the subheader to the monitoring timer when communicating using MC protocol under the following conditions.

(Designated value)

- Target station : FX3U/FX3UC series to which Ethernet adapter is connected : FFH
- Function used : Device memory batch read (bit units) : 00H
- Monitoring timer value : 2500 ms : 000AH

1) Format when communicating in binary code

a) The order when sending a command (external device → Ethernet adapter)

Header	Application data										
	Subheader	PC number	Monitoring timer		Character field (command)						
			(L)	(H)	(Head device number) (L) - - (H)		(Device name) (L) (H)		Number of device points		
00H	FFH	0AH	00H	64H	00H	00H	00H	20H	4DH	08H	00H
	(Local station)	(2500 ms)		(100)			(M)	(8 points)			

b) The order when receiving a response (external device ← Ethernet adapter)

Header	Application data				
	Subheader	Complete code	Character field (response) on/off status of the designated device		
80H	00H	10H	10H	01H	10H
	(Normal completion)	M100(ON) M101(OFF)	M102(ON) M103(OFF)	M105(ON) M104(OFF)	M107(OFF) M106(ON)

- 2) Format when communicating in ASCII code
 - a) The order when sending a command (external device → Ethernet adapter)

Header	Application data								
	Subheader		PC number		Monitoring timer				
	(H)	(L)	(H)	(L)	(H)	(L)	(H)	(L)	
"0"	"0"	"F"	"F"	"0"	"0"	"0"	"A"		
30H	30H	46H	46H	30H	30H	30H	41H		
(Local station)				(2500 ms)					

Application data														
Text (command)														
(Device name)				(Head device number)								Number of device points		
(H)	-	(L)	(H)	-	-	-	-	-	-	(L)	(H)	(L)	(H)	(L)
"4"	"D"	"2"	"0"	"0"	"0"	"0"	"0"	"0"	"0"	"0"	"6"	"4"	"0"	"8"
34H	44H	32H	30H	30H	30H	30H	30H	30H	30H	30H	36H	34H	30H	38H
(M)				(100)								(8 points)		

- b) The order when receiving a response (external device ← Ethernet adapter)

Header	Application data												
	Subheader		Complete		Text (response)								
	(H)	(L)	(H)	(L)	ON/OFF status of the designated device								
"8"	"0"	"0"	"0"	"1"	"0"	"1"	"0"	"0"	"1"	"1"	"0"		
38H	30H	30H	30H	31H	30H	31H	30H	30H	31H	31H	30H		
(Normal completion)													
				M100(ON)		M101(OFF)		M102(ON)		M103(OFF)		M104(OFF)	
				M105(ON)		M106(ON)		M107(OFF)					

1	Introduction
2	Specification
3	System Configuration
4	Installation
5	Wiring
6	Introduction of Functions
7	Communication Using MC Protocol
8	The Operation of GX Works2
9	Troubleshooting
A	List of Special Devices

7.3.4 Character area transmission data

This section explains how to transmit the bit device data and word device data handled in the character areas, as well as the order of transmission when communicating data between an external device and the PLC by each command.

The transmission data shown in the examples is contained in character area B when reading, and in character area C when writing, testing.

1) Data communication using ASCII code

a) When reading from or writing to a bit device memory

The bit device memory can be read and written in bit units (one device point) or word units (16 device points).

How data is transmitted in each case is explained below.

- Bit units (one point)

In case of bit units, the bit device memory is handled from the designated head device for the number of designated device points sequentially from the left. They are expressed as "1" (31H) if the device is on or "0" (30H) if the device is off.

(Example)

Indicating the ON/OFF status of five points from M10

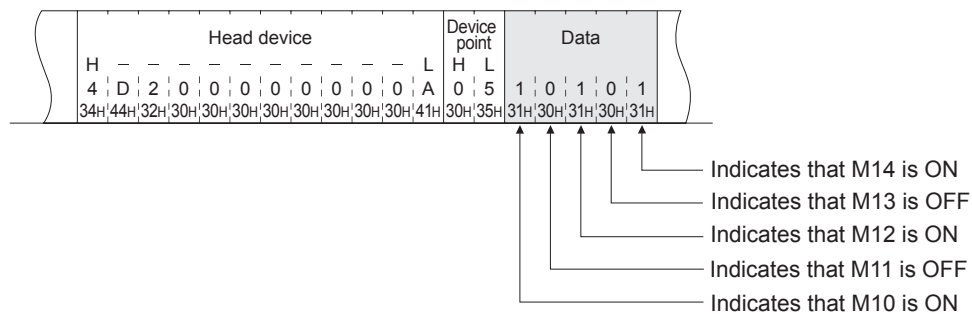

- Word units (16 points)

When the bit device memory is handled as word units, each word is expressed in hexadecimal values in 4-bit units sequentially from the higher bit.

(Example)

Indicating the ON/OFF status of 32 points from M16

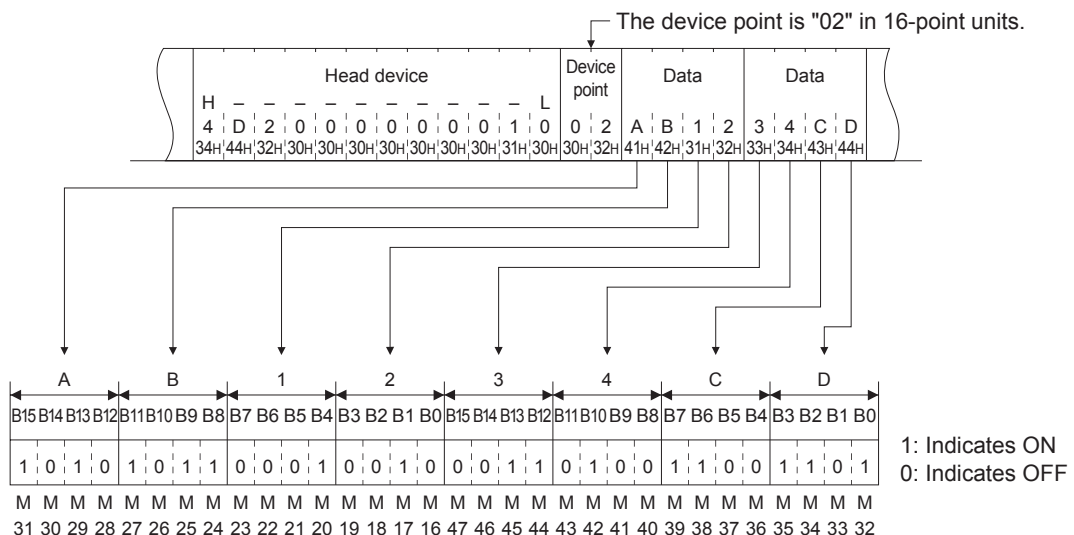

- b) When reading from or writing to a word device memory
 Each word of the word device memory is expressed in hexadecimal values in 4-bit units sequentially from the higher bit.

(Example)

Indicating the storage contents of data registers D350 and D351

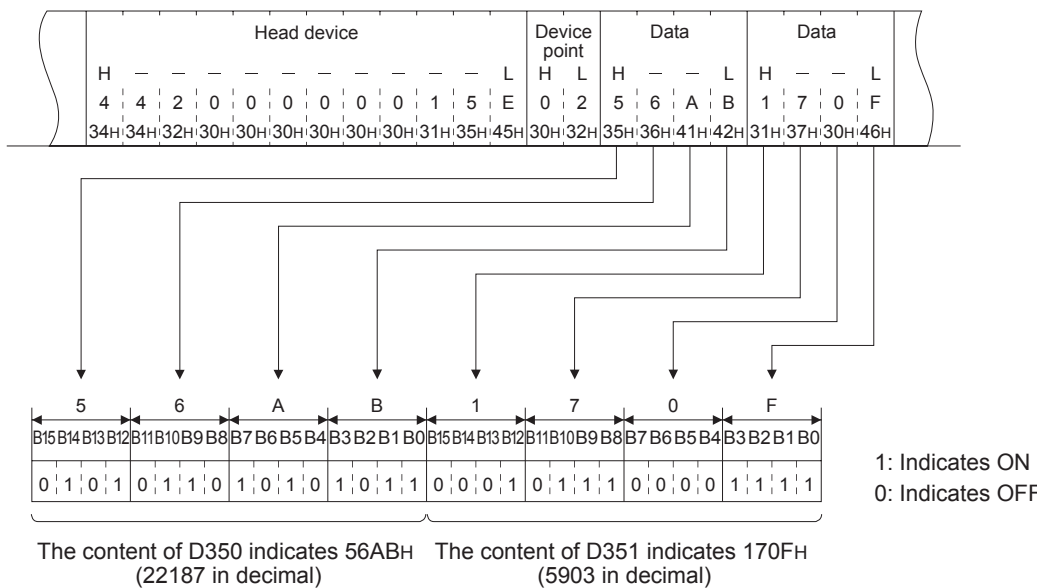

<Point>

- When designating alphabet letters in the character area, use upper case.
- When data other than an integer value (real number, character string) is stored in a word device memory to be read, the stored value is read as an integer value.

(Example 1)

When the real number (0.75) is stored in D0 and D1, it is read as the following integer values:
 D0 = 0000H, D1 = 3F40H

(Example 2)

When the character string ("12AB") is stored in D2 and D3, it is read as the following integer values:
 D2 = 3231H, D3 = 4241H

1	Introduction
2	Specification
3	System Configuration
4	Installation
5	Wiring
6	Introduction of Functions
7	Communication Using MC Protocol
8	The Operation of GX Works2
9	Troubleshooting
A	List of Special Devices

2) Data communication using binary code

a) When reading from or writing to a bit device memory

The bit device memory can be read and written in bit units (one device point) or word units (16 device points).

How data is transmitted in each case is explained below.

• Bit units (one point)

In case of bit units, four bits designate one point and the bit device memory is handled from the designated head device for the number of designated device points sequentially from the left. They are expressed as "1" if the device is ON or "0" if the device is OFF.

(Example)

Indicating the ON/OFF status of five points from M10

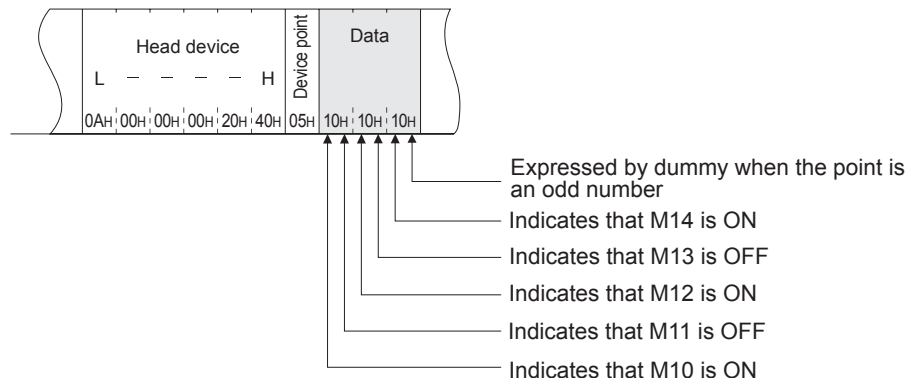

• Word units (16 points)

In case of word units, one bit designates one point and the bit device memory is handled from the designated head device for the number of designated device points sequentially from the left. They are expressed in 16-point units in the order, low byte (L: bits 0 to 7) to high byte (H: bits 8 to 15).

(Example)

Indicating the ON/OFF status of 32 points from M16

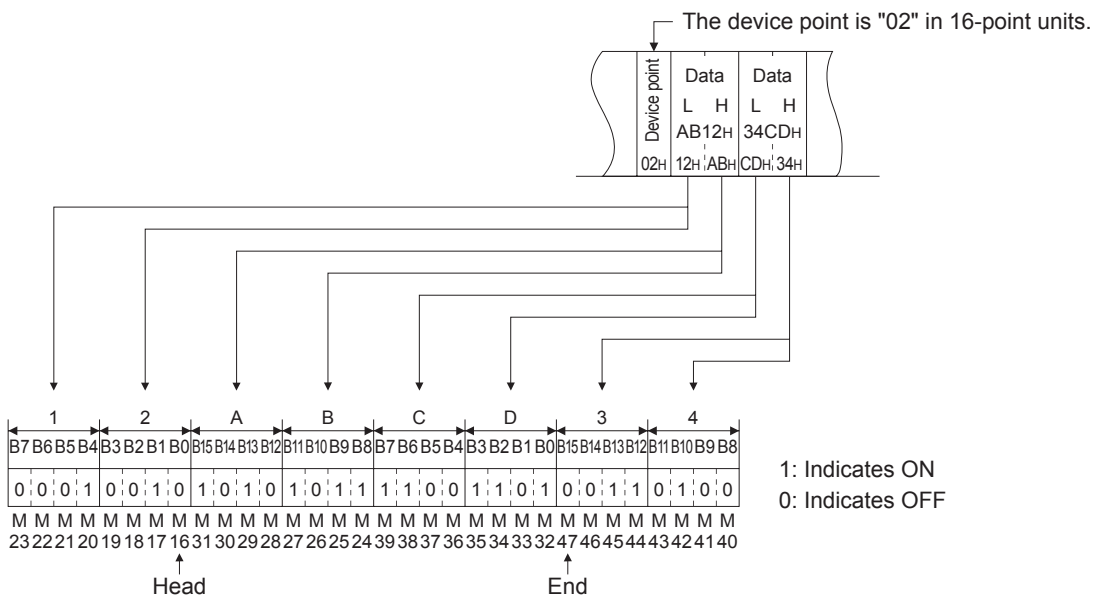

b) Reading from or writing to a word device memory

Each word of a word device memory is designated by 16 bits and the designated number of points from the designated head device are sequentially expressed in one-point units in the order, low byte (L: bits 0 to 7) to high byte (H: bits 8 to 15).

(Example)

Indicating the storage contents of data registers D350 and D351

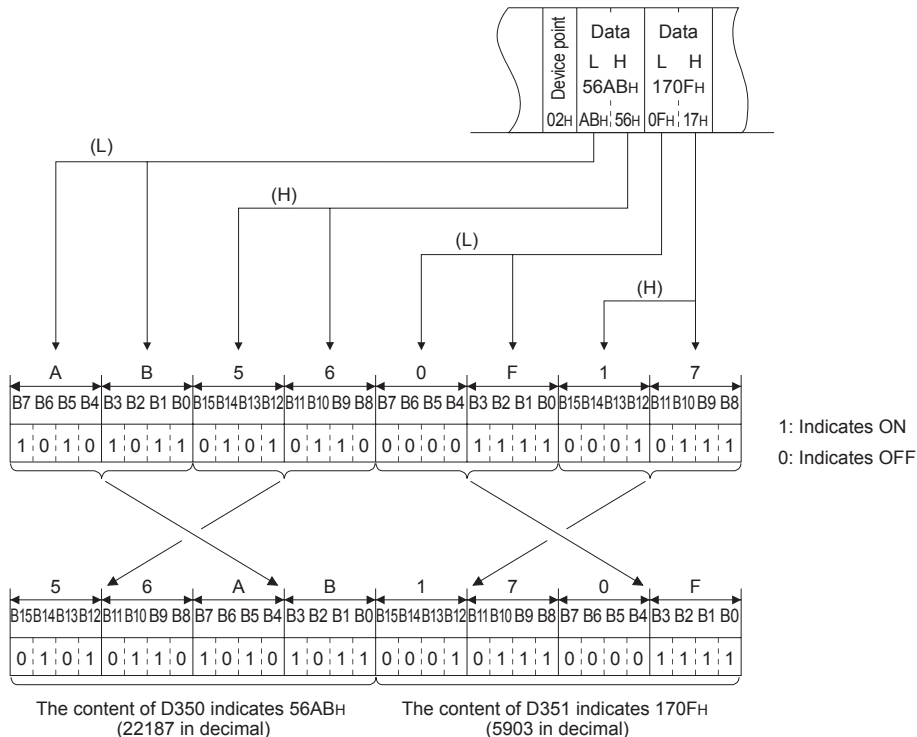

<Point>

When data other than an integer value (real number, character string, etc.) is stored in a word device memory to be read, the adapter reads the stored value as an integer value.

(Example 1)

When the real number (0.75) is stored in D0 and D1, it is read as the following integer values:

D0 = 0000H, D1 = 3F40H

(Example 2)

When the character string ("12AB") is stored in D2 and D3, it is read as the following integer values:

D2 = 3231H, D3 = 4241H

1	Introduction
2	Specification
3	System Configuration
4	Installation
5	Wiring
6	Introduction of Functions
7	Communication Using MC Protocol
8	The Operation of GX Works2
9	Troubleshooting
A	List of Special Devices

7.4 List of Commands and Functions for The MC protocol

The following table lists the commands and functions when an external device accesses the PLC.

Function		Command/ response type	Processing	Number of points processed per communication	
Device memory	Batch read	Bit units	00H	Reads bit devices (X, Y, M, S, T, C) in 1-point units.	256 points
		Word units	01H	Reads bit devices (X, Y, M, S, T, C) in 16-point units.*1	32 words (512 points)
	Reads word devices (D, R, T, C) in 1-point units.*2*3 The maximum number of communication points is 32 when C200 or more is specified.			64 points	
	Batch write	Bit units	02H	Writes to bit devices (X, Y, M, S, T, C) in 1-point units.	160 points
		Word units	03H	Writes to bit devices (X, Y, M, S, T, C) in 16-point units.*1	10 words (160 points)
	Writes to word devices (D, R, T, C) in 1-point units.*2*3 The maximum number of communication points is 32 when C200 or more is specified.			64 points	
	Test (Random write)	Bit units	04H	Sets/resets bit devices (X, Y, M, S, T, C) in 1-point units by arbitrarily designating the devices and device number.	80 points
		Word units	05H	Sets/resets bit devices (X, Y, M, S, T, C) in 16-point units by arbitrarily designating the devices and device number.	10 words (160 points)
Sets/resets word devices (D, R, T, C) in 1-point units by arbitrarily designating the devices and device numbers. Not applicable for 32 bit devices from C200 to C255.	10 points				
PLC control	Remote RUN		13H	Requests remote RUN/STOP to PLC.	-
	Remote STOP		14H		
	PLC model name read		15H	Reads PLC model name code.	-
Loopback test		16H	Returns the character received from the other node to that node with the data as it is.	254 bytes	

*1. Make sure to set a multiple of 16 as the head device number of bit devices.

*2. Read or write 32 bits at a time when reading or writing double-word data in a user program, etc.

*3. It is not possible to specify C199 or lower (16 bits) and C200 or higher (32 bits) at the same time.

MEMO

1	Introduction
2	Specification
3	System Configuration
4	Installation
5	Wiring
6	Introduction of Functions
7	Communication Using MC Protocol
8	The Operation of GX Works2
9	Troubleshooting
A	List of Special Devices

7.5 Device Memory Read/Write

This section explains the designations in the control procedure when reading from and writing to device memory by providing an example.

7.5.1 Commands and device range

1) Commands used for reading from and writing to device memory

Item	Command/ response type	Processing	Number of points processed per communication	
Batch read	Bit units	00H	Reads bit devices (X, Y, M, S, T, C) in 1-point units.	256 points
	Word units	01H	Reads bit devices (X, Y, M, S, T, C) in 16-point units.* ¹	32 words (512 points)
Reads word devices (D, R, T, C) in 1-point units.* ^{2,3} The maximum number of communication points is 32 when C200 or higher is specified.			64 points	
Batch write	Bit units	02H	Writes to bit devices (X, Y, M, S, T, C) in 1-point units.	160 points
	Word units	03H	Writes to bit devices (X, Y, M, S, T, C) in 16-point units.* ¹	10 words (160 points)
Writes to word devices (D, R, T, C) in 1-point units.* ^{2,3} The maximum number of communication points is 32 when C200 or higher is specified.			64 points	
Test (Random write)	Bit units	04H	Sets/resets bit devices (X, Y, M, S, T, C) in 1-point units by arbitrarily designating the devices and device number.	80 points
	Word units	05H	Sets/resets bit devices (X, Y, M, S, T, C) in 16-point units by arbitrarily designating the devices and device number.	10 words (160 points)
Sets/resets word devices (D, R, T, C) in 1-point units by arbitrarily designating the devices and device numbers. Not applicable for 32 bit devices from C200 to C255.			10 points	

*1. Make sure to set a multiple of 16 as the head device number of bit devices.

*2. Read or write 32 bits at a time when reading or writing double-word data in a user program, etc.

*3. It is not possible to specify C199 or lower (16 bits) and C200 or higher (32 bits) at the same time.

2) Designation method and accessible range of devices.

a) In device read/write, each device is set by a device code and number as shown in the diagram below.

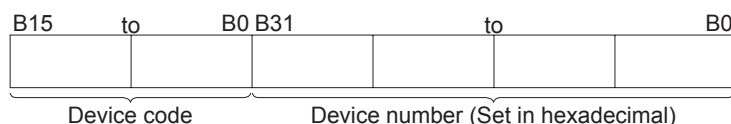

[Example] In case of D100
 D100 = 4420 00000064H
 → Device number (hexadecimal)
 → Device code

b) The following table outlines the device codes and numbers.

Device		Device code	Device range	Device number
Data register* ¹		D (44H, 20H)	D0 to D7999	0000 to 1F3FH
			D8000 to D8511	1F40 to 213FH
Extension register		R (52H, 20H)	R0 to R32767	0000 to 7FFFH
Timer	Current value	TN (54H, 4EH)	T0 to T511	0000 to 01FFH
	Contact	TS (54H, 53H)	T0 to T511	0000 to 01FFH
Counter	Current value* ²	CN (43H, 4EH)	C0 to C199	0000 to 00C7H
			C200 to C255	00C8 to 00FFH
	Contact	CS (43H, 53H)	C0 to C199	0000 to 00C7H
			C200 to C255	00C8 to 00FFH
Input		X (58H, 20H)	X0 to X377	0000 to 00FFH
Output		Y (59H, 20H)	Y0 to Y377	0000 to 00FFH
Auxiliary relay		M (4DH, 20H)	M0 to M7679	0000 to 1DFFH
			M8000 to M8511	1F40 to 213FH
State		S (53H, 20H)	S0 to S4095	0000 to 0FFFH

*1. It is not possible to specify D7999 or lower and D8000 or higher at the same time.

*2. It is not possible to specify C199 or lower (16 bits) and C200 or higher (32 bits) at the same time.

Caution

- Bit devices and word devices are classified according to the following.
Bit devices : X, Y, M, S, T (contact), C (contact)
Word devices : T (current value), C (current value), D, R
- When word units are designated, always make the head device number of a bit device a multiple of 16 (0, 16... in decimal representation).
For X and Y is expressed in octadecimal, the device numbers that can be designated are X00, X20, X40,,, or Y00, Y20, Y40,,,
Also, special auxiliary relays M8000 or later can be specified (8000 + multiples of 16).
- The special auxiliary relays (M8000 to M8511) and special data registers (D8000 to D8511) are divided into read only, write only and system use registers.
If writing takes place outside the writing enabled range, a PLC error may occur.
For details of special auxiliary relays and special data registers, refer to the Programming Manual and Appendix A.

7.5.2 Batch read in bit units (command: 00)

The examples shown in this section explain the command/response format when batch-reading bit device memory.

For more details on the order and content of data items of the areas marked by " * " shown in the control procedure diagram, refer to Subsection 7.3.2.

[Control procedure]

Reading the on/off status of M100 to M111 of the PLC on which the Ethernet adapter is loaded.

1) Communication in binary code

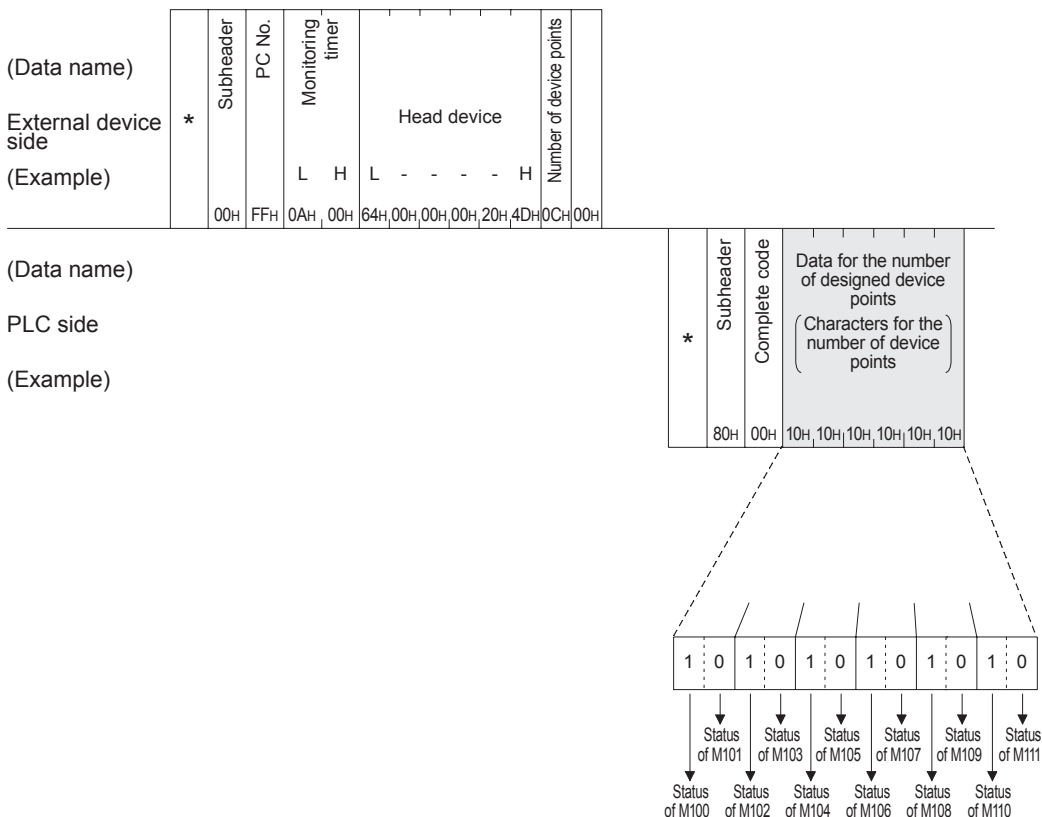

Caution

- Use the designation "00H" when the number of device points is 256 points.
- If the number of device points designated is an odd number, 4 bits of dummy data (0H) will be added to the response data. For example, if three points are read, data for four points is returned. The last 4 bits are dummy data.

7.5.3 Batch write in bit units (command: 02)

The examples shown in this section explain the command/response format when batch writing to bit device memory.

For more details on the order and content of data items of the areas marked by " * " shown in the control procedure diagram, refer to Subsection 7.3.2.

[Control procedure]

Writing the on/off status of M50 to M61 of the PLC on which the Ethernet adapter is loaded.

- 1) Communication in binary code

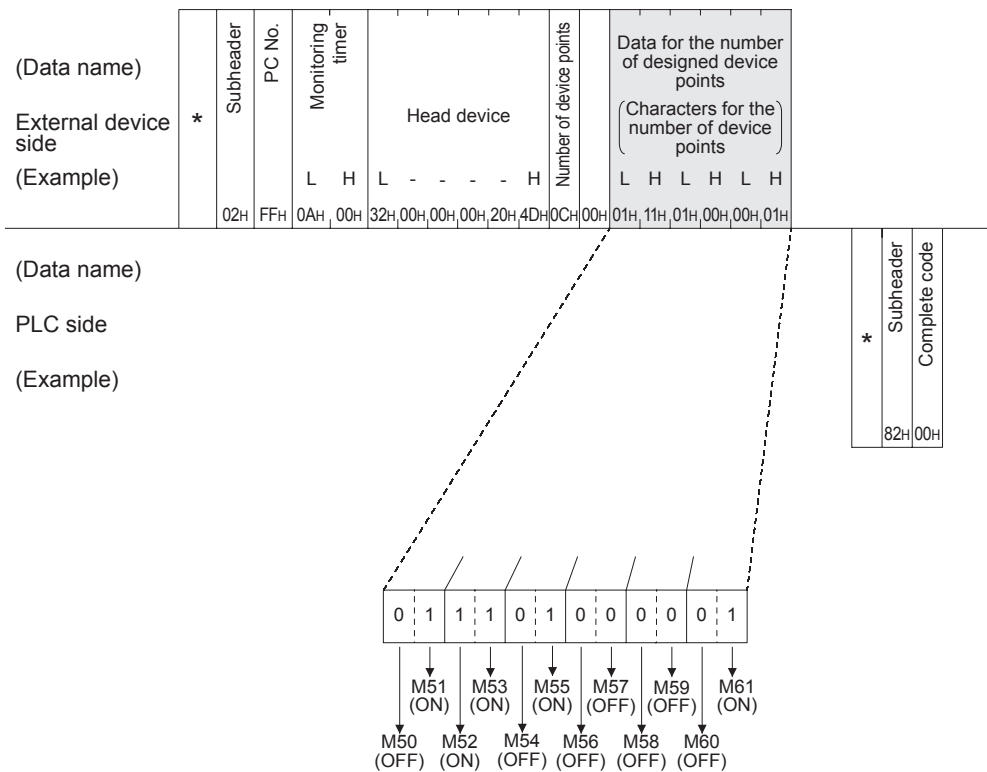

Caution

If the number of device points to be set is an odd number, add 4 bits of dummy data (0H) at the end of data written. For example, when writing three points, add the dummy data (0H) at the end.

2) Communication in ASCII code

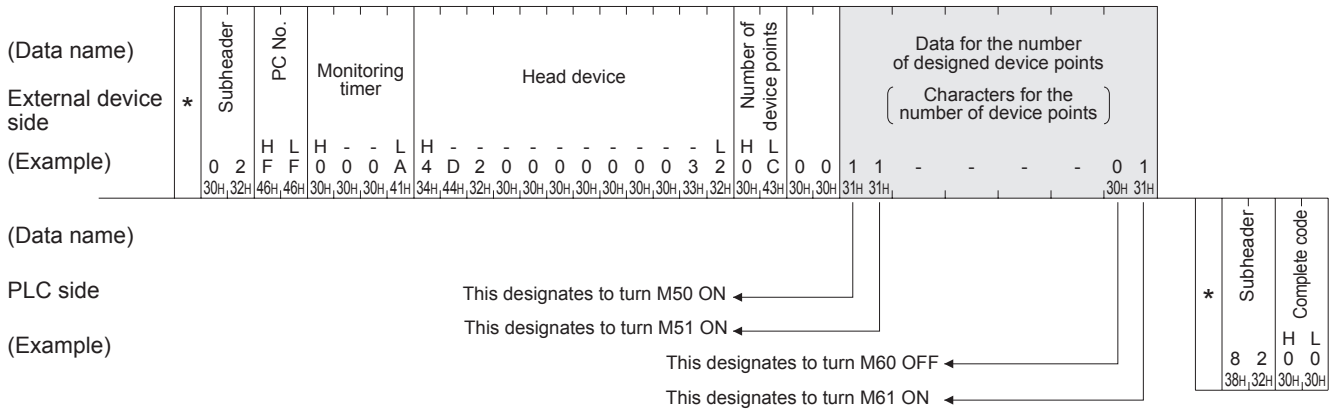

Caution

If the number of device points to be set is an odd number, add one byte of dummy data (30H) at the end of data written. For example, when writing three points, add the dummy data (30H) at the end.

7.5.4 Test in bit units (random write) (command: 04)

The examples shown in this section explain the command/response format when writing data by designating bit device memories arbitrarily.

For more details on the order and content of data items of the areas marked by " * " shown in the control procedure diagram, refer to Subsection 7.3.2.

[Control procedure]

Specifying Y45 to ON, M60 to OFF, and S38 to ON at the PLC on which the Ethernet adapter is loaded.

1) Communication in binary code

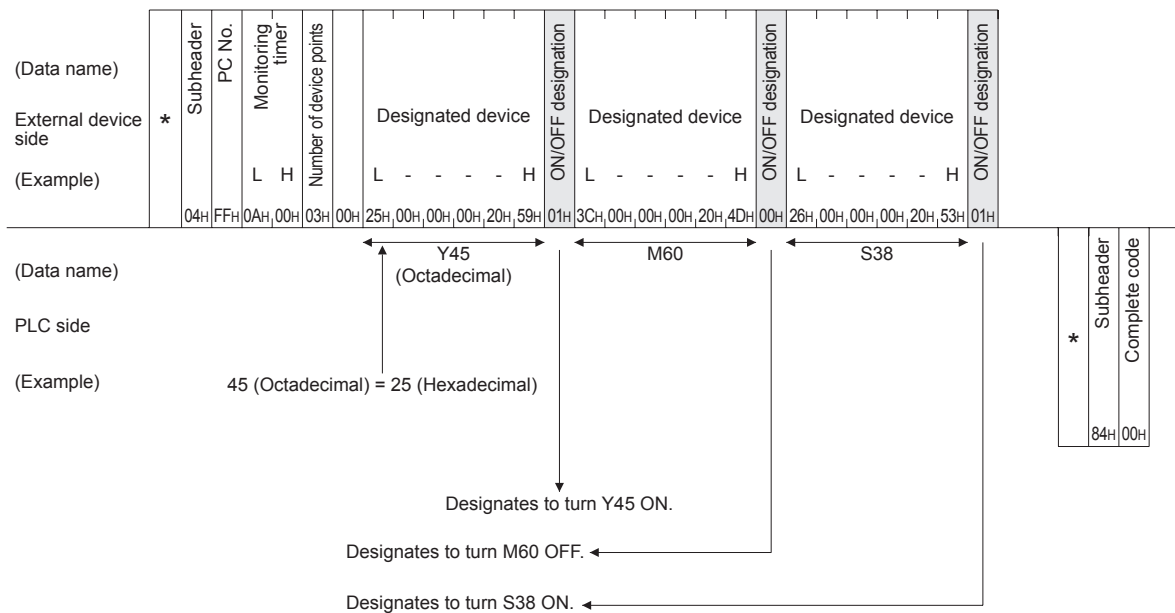

1 Introduction

2 Specification

3 System Configuration

4 Installation

5 Wiring

6 Introduction of Functions

7 Communication Using MC Protocol

8 The Operation of GX Works2

9 Troubleshooting

A List of Special Devices

2) Communication in ASCII code

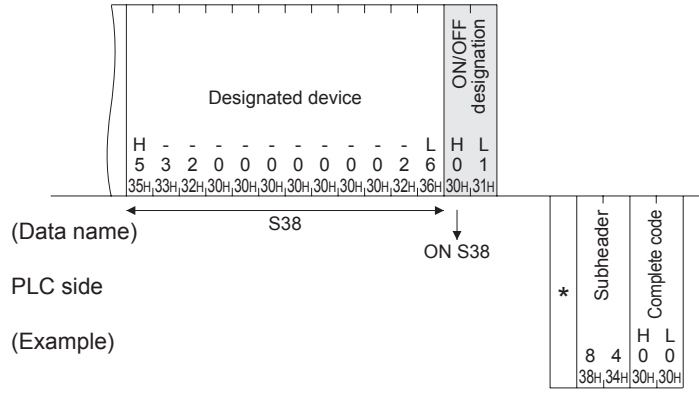
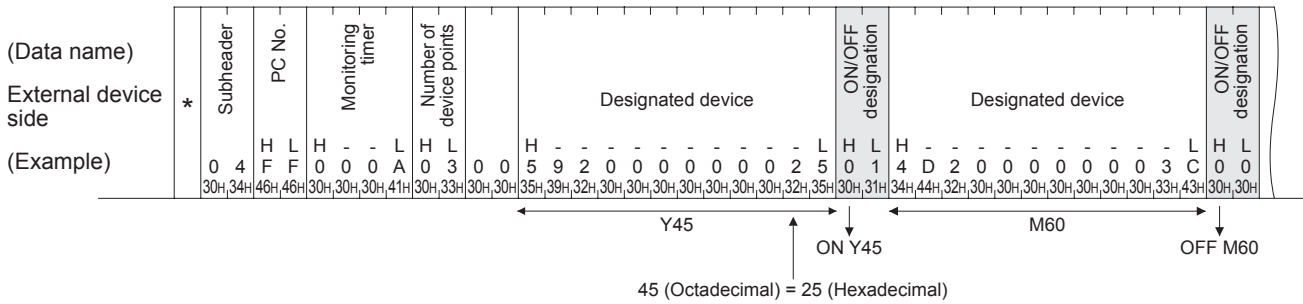

7.5.5 Batch read in word units (command: 01)

The examples shown in this section explain the command/response format when batch reading word device memory or bit device memory (16 point units).

For more details on the order and content of data items of the areas marked by "*" shown in the control procedure diagram, refer to Subsection 7.3.2.

[Control procedure]

Reading the on/off status of Y100 to Y137 (32 points) of the PLC on which the Ethernet adapter is loaded.

1) Communication in binary code

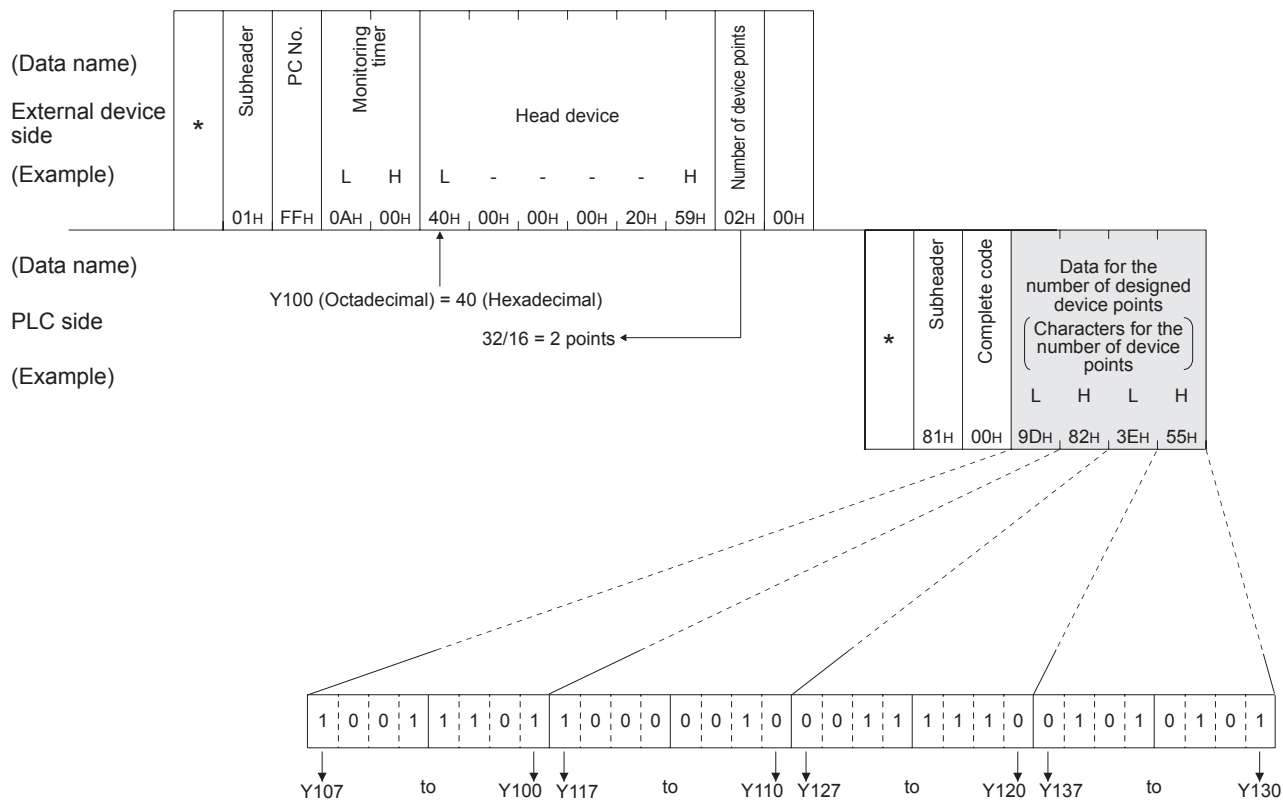

1	Introduction
2	Specification
3	System Configuration
4	Installation
5	Wiring
6	Introduction of Functions
7	Communication Using MC Protocol
8	The Operation of GX Works2
9	Troubleshooting
A	List of Special Devices

2) Communication in ASCII code

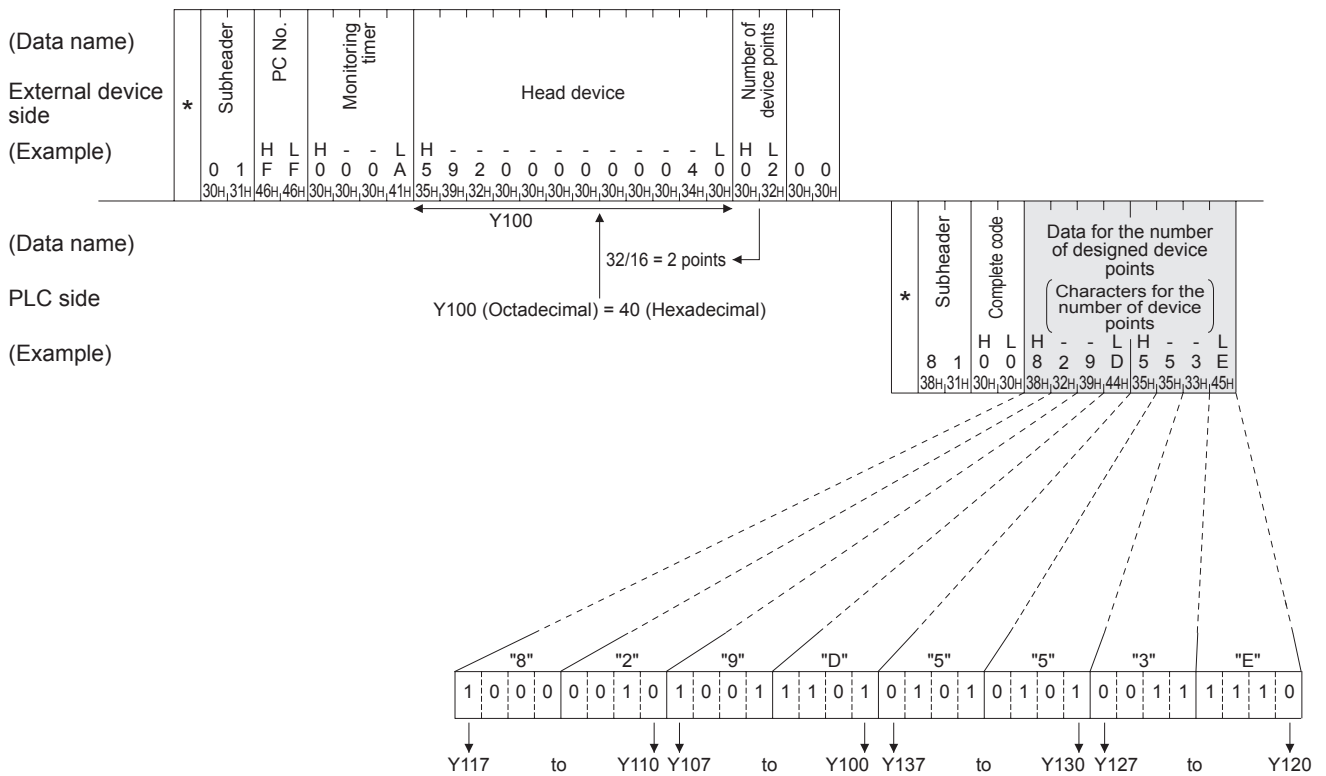

<Note>

C200 to C255 (Current Values) Batch Read

Since C200 to C255 are 32 bit devices, the device points should be specified with twice as many points as are actually read.

Also, make sure that the device points are specified by an even number.

If they are specified by an odd number, the batch read cannot be performed. (Error code 57H will be stored)

Example) When 32 devices are read at one access from C220 to C251 in the PLC on which the Ethernet adapter is mounted.

1) Communication in binary code

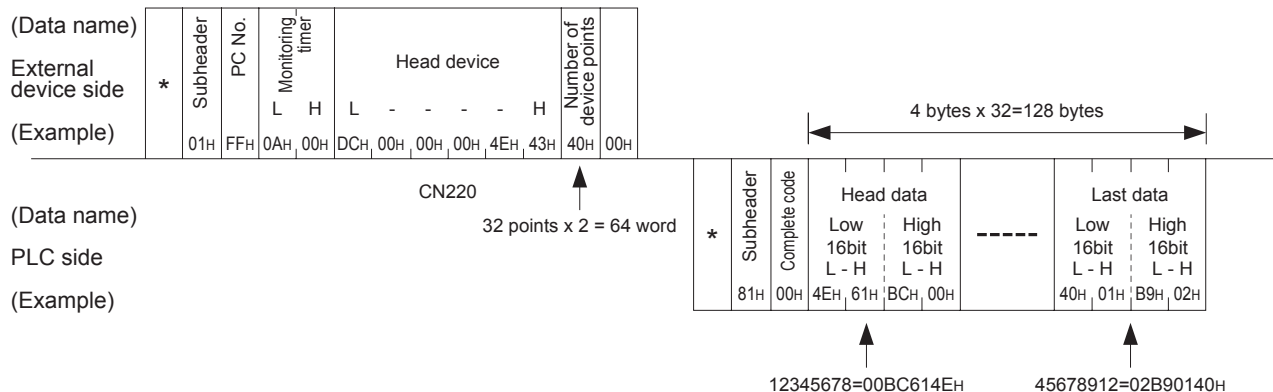

7.5.6 Batch write in word units (command: 03)

The examples shown in this section explain the command/response format when batch writing to word device memory or bit device memory (16 point units).

For more details on the order and content of data items of the areas marked by " * " shown in the control procedure diagram, refer to Subsection 7.3.2.

[Control procedure]

Writing data to D100 to D102 of the PLC on which the Ethernet adapter is loaded.

- 1) Communication in binary code

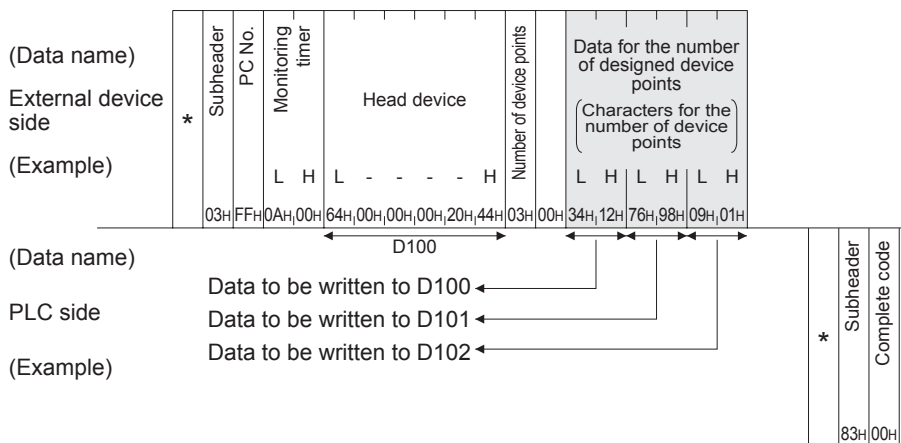

7.6 Remote RUN/STOP, PLC model name code read

This function is used to remotely RUN/STOP a PLC and read the model name of a PLC from an external device.

7.6.1 Commands and control contents

This section describes the commands and control contents of the control procedure when controlling the status of the PLC.

1) Commands

Function	Command / Response type	Processing
Remote RUN	13H	Requests remote RUN (execute operation) Executes a forced RUN regardless of the RUN/STOP switch status of PLC.
Remote STOP	14H	Requests remote STOP (stop operation) Executes a forced STOP regardless of the RUN/STOP switch status of PLC.
PLC model name read	15H	Request to read the model name of the PLC.

7.6.2 Remote RUN (command: 13H)/Remote STOP (Command: 14H)

The examples shown in this section explain the control procedure of remote RUN. The order and content of data items of the areas marked by "*" shown in the control procedure diagram differ depending on the module used as well as the frame and format used for communication. For details, refer to Subsection 7.3.2.

[Control procedure]

1) Executing remote RUN while communicating in binary code

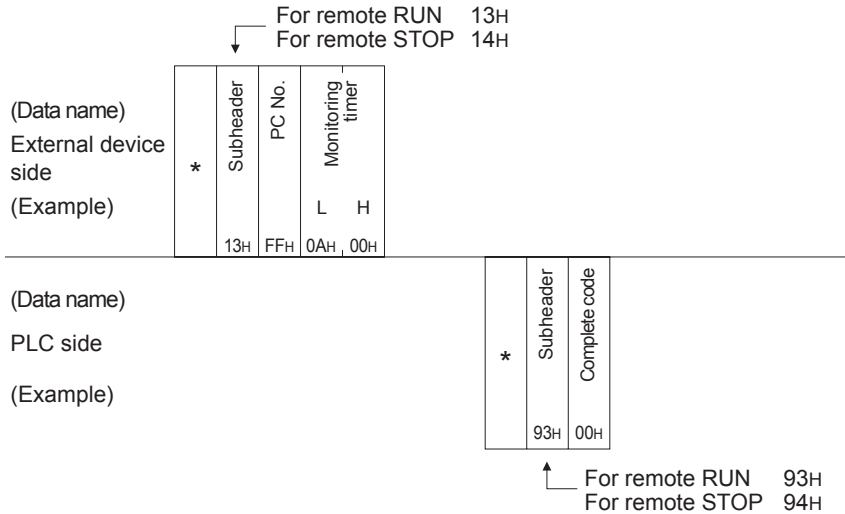

2) Executing remote RUN while communicating in ASCII code

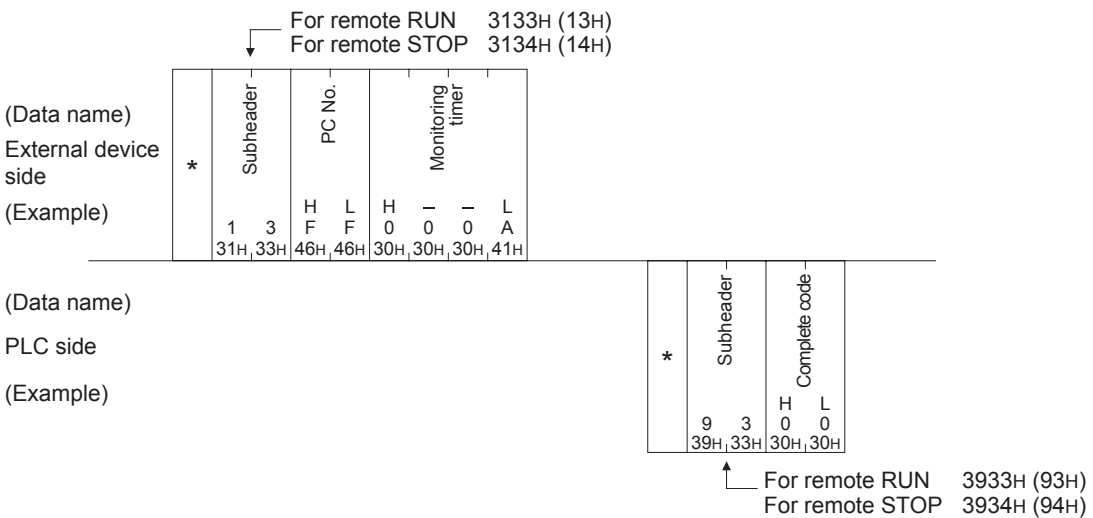

Caution

- When executing the remote RUN/STOP using other external devices or computer link, the remote RUN/STOP is executed in the order of execution.
- When the power of PLC is turned on, then off, and then on again with the remote RUN/STOP executed, the remote RUN/STOP status is canceled and the setting of the PLC's RUN/STOP switch becomes valid.

1 Introduction
2 Specification
3 System Configuration
4 Installation
5 Wiring
6 Introduction of Functions
7 Communication Using MC Protocol
8 The Operation of GX Works2
9 Troubleshooting
A List of Special Devices

7.6.3 PLC model name read (command: 15H)

The examples shown in this section explain the control procedure for reading the model name of the PLC. The order and content of data items of the areas marked by "*" shown in the control procedure diagram differ depending on the module used as well as the frame and format used for communication. For details, refer to Subsection 7.3.2.

[Control procedure]

1) Data communication in binary code

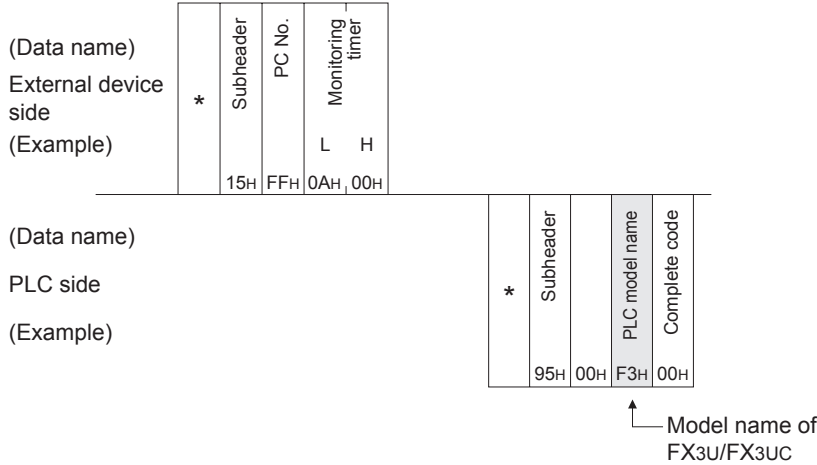

2) Data communication in ASCII code

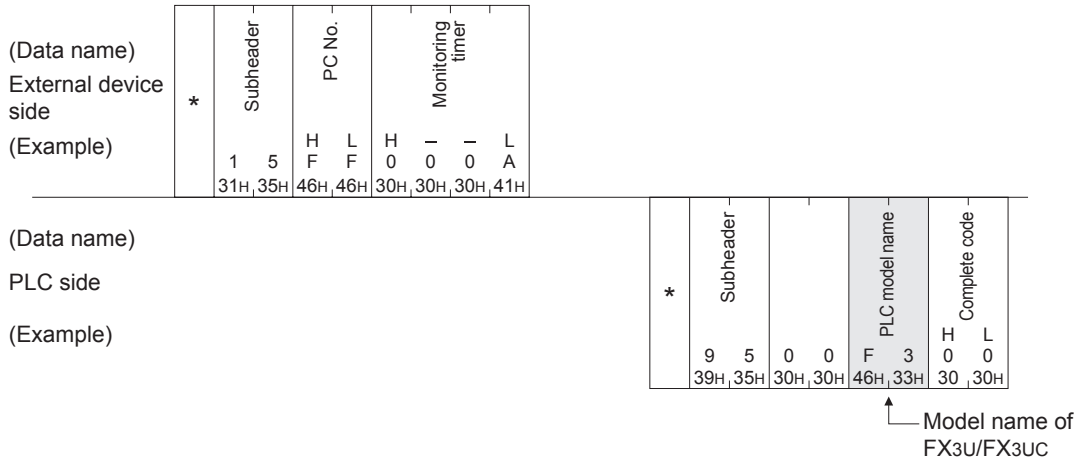

Caution

Distinguish the PLC model name by the model name code. "F3H", which is the model code of FX3U/FX3UC, is read as the PLC model name.

MEMO

1	Introduction
2	Specification
3	System Configuration
4	Installation
5	Wiring
6	Introduction of Functions
7	Communication Using MC Protocol
8	The Operation of GX Works2
9	Troubleshooting
A	List of Special Devices

7.7 Loopback Test

A loopback test checks whether or not the communication function between an external device and the Ethernet adapter operates normally. The examples show the control procedure using this function.

Caution

- A loopback test checks whether or not the connection between the external device and the Ethernet adapter is correct and that the data communication function operates properly when the Ethernet adapter is started up or when a problem occurs.
- Use the following data for loopback tests. Send the head part first.
 - When communicating in binary code
Maximum of 254 bytes of numerical values (00 to FFH).
 - When communicating in ASCII code
Maximum of 254 single-byte characters ("0" to "9", "A" to "F").

7.7.1 Loopback test (command: 16H)

The examples shown in this section explain the control procedure for an external device performing a loopback test with the Ethernet unit.

The order and content of data items of the areas marked by "*" shown in the control procedure diagram differ depending on the module used as well as the frame and format used for communication.

For details, refer to Subsection 7.3.2.

[Control procedure]

- 1) Performing a loopback test while communicating in binary code

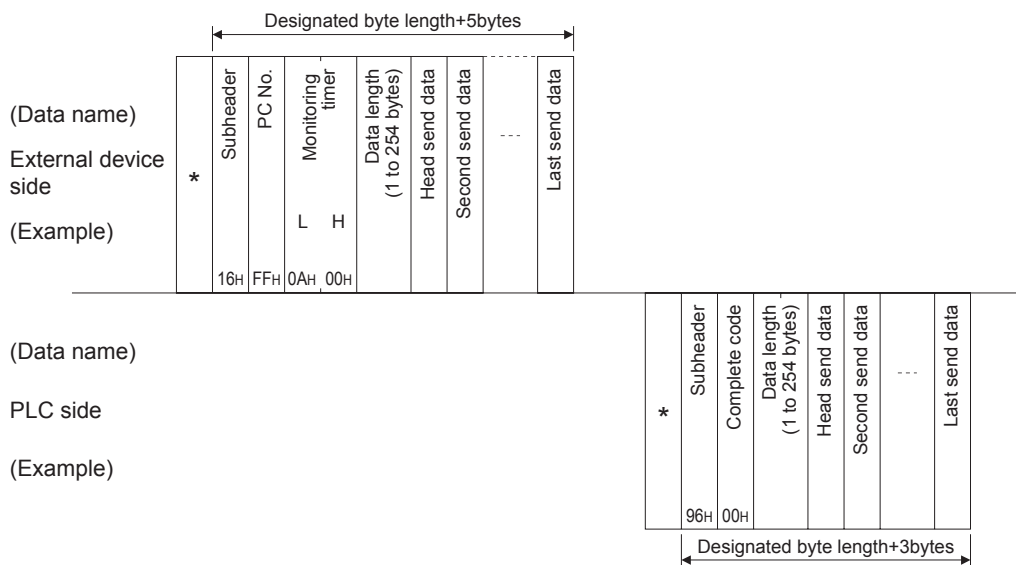

1 Introduction

2 Specification

3 System Configuration

4 Installation

5 Wiring

6 Introduction of Functions

7 Communication Using MC Protocol

8 The Operation of GX Works2

9 Troubleshooting

A List of Special Devices

2) Performing a loopback test while communicating in ASCII code

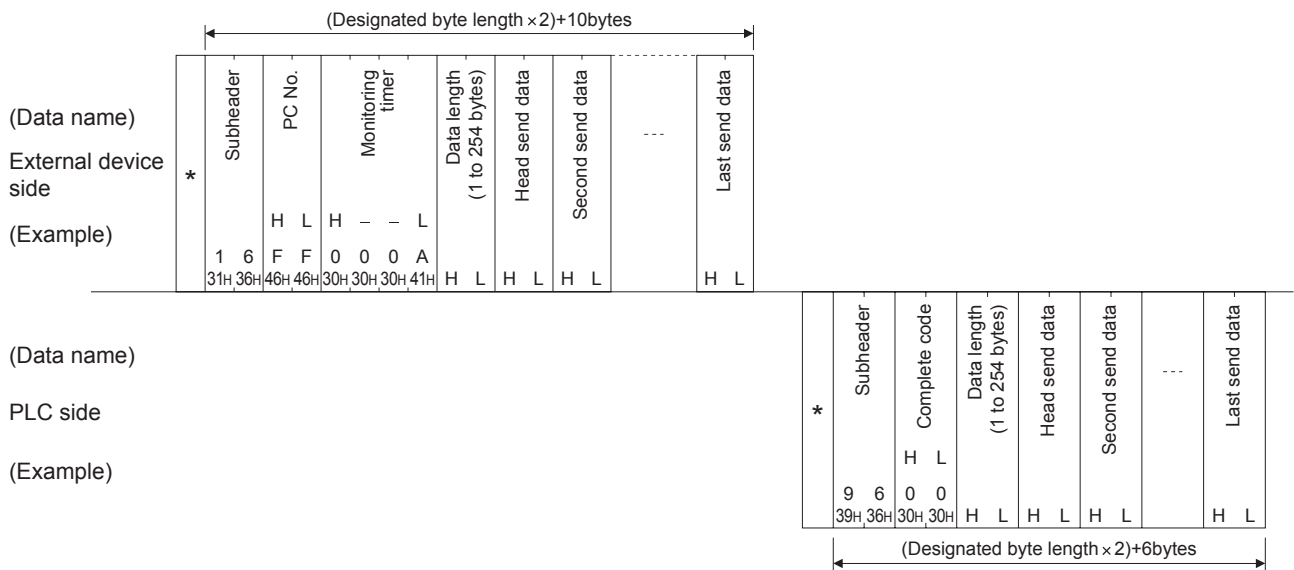

Caution

The loopback data transmitted by an external device is returned to the external device as is.

8. The Operation of GX Works2

This chapter explains operations of GX Works 2 related to the Ethernet adapter setting and others. GX Works2 Ver. 1.73B and later supports the Ethernet adapter setting. In order to set up the Ethernet adapter by GX Works2, FX Configurator-EN needs to be installed. For operation of GX Works2, refer to the GX Works2 Version 1 Operating Manual (Common). For descriptions of each function, refer to Chapter 6.

8.1 Ethernet adapter Setting

Set Ethernet adapter on the "Ethernet Adapter" tab of the "FX Parameter" screen.

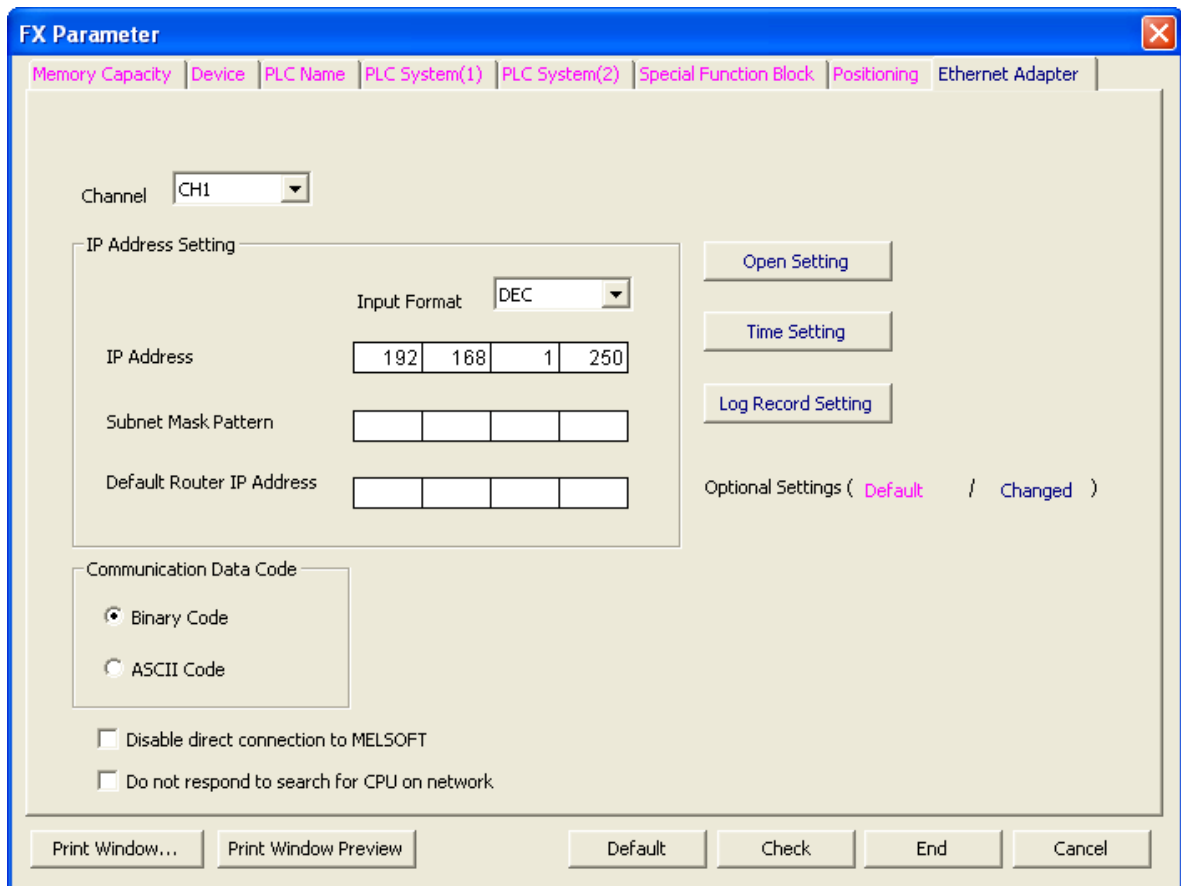

Setting	Description
Channel	Select whether or not the Ethernet adapter is connected. When it is connected, specify the channel connected to the Ethernet adapter. [Setting] <ul style="list-style-type: none"> • Not Set • CH1 • CH2
Input Format	Select the input format and display format used to set the IP address, subnet mask pattern and default router IP address. [Setting] <ul style="list-style-type: none"> • Decimal • Hexadecimal
IP Address*1	Set the Ethernet adapter IP address. [Setting range] <ul style="list-style-type: none"> • 0.0.0.1 to 223.255.255.254 (Decimal) • 00.00.00.01 to DF.FF.FF.FE (Hexadecimal)

Setting	Description
Subnet Mask Pattern *1	Specify the subnet mask pattern. [Setting range] <ul style="list-style-type: none"> 192.0.0.0 to 255.255.255.252 (Decimal) C0.00.00.00 to FF.FF.FF.FC (Hexadecimal)
Default Router IP Address *1	Specify the IP address of the default router when it is used. [Setting range] <ul style="list-style-type: none"> 0.0.0.1 to 223.255.255.254 (Decimal) 00.00.00.01 to DF.FF.FF.FE (Hexadecimal)
Communication Data Code	Select the data code used for communication using the MC protocol. <ul style="list-style-type: none"> Binary Code Communicates by binary code. ASCII Code Communicates by ASCII code.
Disable direct connection to MELSOFT	Select whether or not direct connection to MELSOFT is disabled.
Do not respond to search for CPU on network	Select whether or not response is given to search for CPU on the network.
Open Setting	A click of the button will display "Ethernet Adapter Open Setting" screen. For details, refer to Section 8.2.
Time Setting	A click of the button will display "Ethernet Adapter Time Setting" screen. For details, refer to Section 8.3.
Log Record Setting	A click of the button will display "Ethernet Adapter Log Record Setting" screen. For details, refer to Section 8.4.

*1. Set the IP address, subnet mask pattern and default router IP address upon consulting a network administrator.

1

Introduction

2

Specification

3System
Configuration**4**

Installation

5

Wiring

6Introduction of
Functions**7**Communication
Using
MC Protocol**8**The Operation
of GX Works2**9**

Troubleshooting

AList of Special
Devices

8.2 Open Setting

On the "Ethernet Adapter Open Setting" screen, set the protocol, open system and others. Up to four connections can be set up.

MELSOFT connection + MC protocol <= 4 connection

Click the [Open Setting] button on the "Ethernet Adapter" screen to display the screen below.

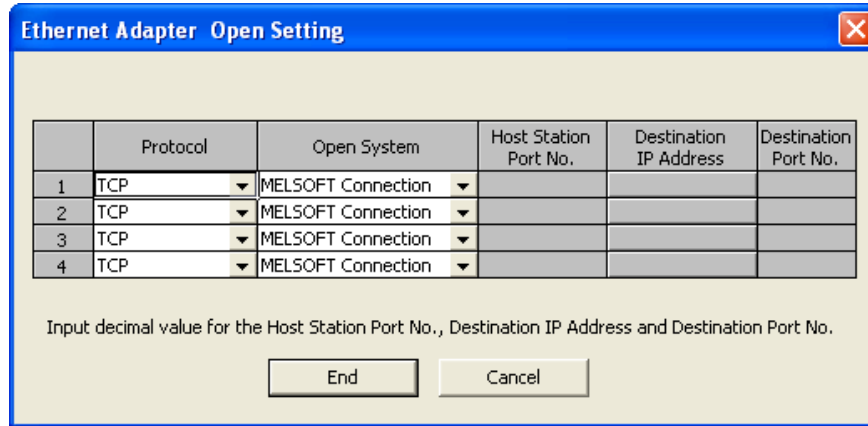

Setting	Description
Protocol	Specify a protocol to be used. [Setting] <ul style="list-style-type: none"> • Not Set (The "Open System" and "Host Station Port No." columns are displayed in gray.) • TCP • UDP
Open System	Select the open system. [Setting] <ul style="list-style-type: none"> • TCP: Select "MELSOFT Connection" or "MC Protocol". • UDP: The open system is fixed to "MC Protocol" (displayed in gray).
Host Station Port No.	Set host station port No. (This column is valid only when the selected open system is "MC Protocol".) [Setting range] <ul style="list-style-type: none"> • MC protocol: 1025 to 5548 or 5560 to 65534
Destination IP Address	Set destination IP address. (This column is valid only when the selected protocol is "UDP" and the selected open system is "MC Protocol".) When this column is valid, "No Setting" is displayed in red. Click "No Setting" to display the IP address setting dialog which allows setting of the IP address. When setting of the IP address is completed, the entered IP address is displayed in blue. [Setting range] <ul style="list-style-type: none"> • 0.0.0.1 to 255.255.255.254 (decimal)
Destination Port No.	Set destination port No. (This column is valid only when the selected protocol is "UDP" and the selected open system is "MC Protocol".) [Setting range] <ul style="list-style-type: none"> • 1025 to 65534

8.2.1 MELSOFT connections

MELSOFT connection can be set by selecting "TCP" in the "Protocol" column and selecting "MELSOFT Connection" in the "Open System" column for the used connection No. on the "Ethernet Adapter Open Setting" screen.

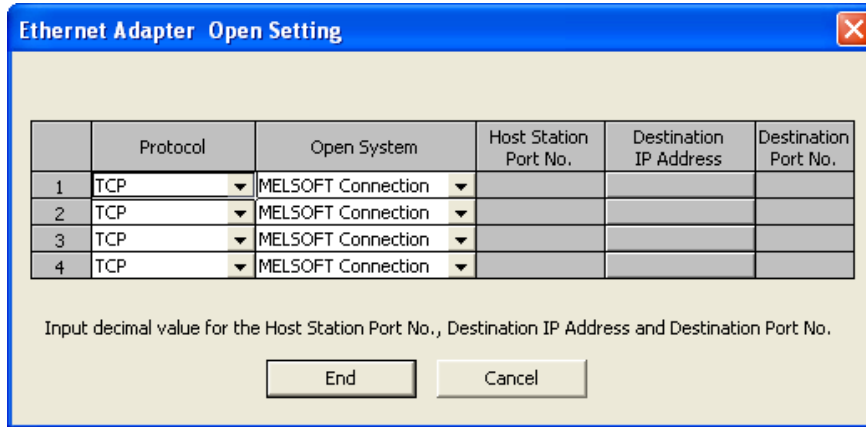

8.2.2 MC protocol

MC protocol can be set by selecting "TCP" in the "Protocol" column and selecting "MC Protocol" in the "Open System" column for the used connection No. on the "Ethernet Adapter Open Setting" screen, or by selecting "UDP" in the "Protocol" column for the used connection No. on the "Ethernet Adapter Open Setting" screen.

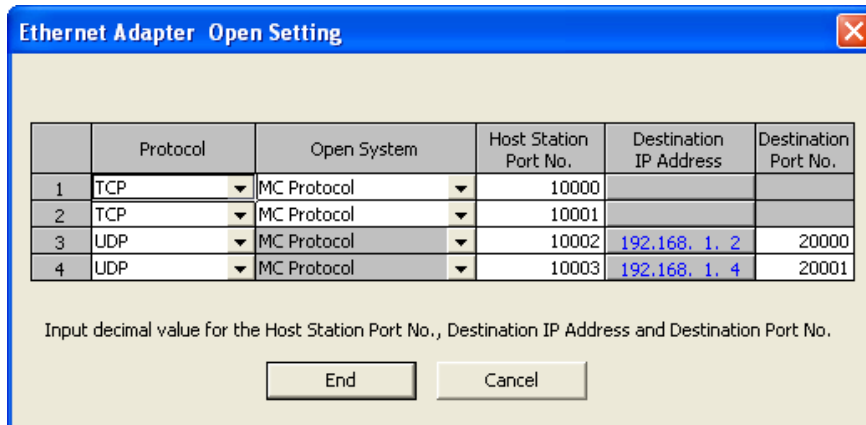

When "UDP" is selected in the "Protocol" column, the open system is fixed to "MC Protocol" and does not allow selection.

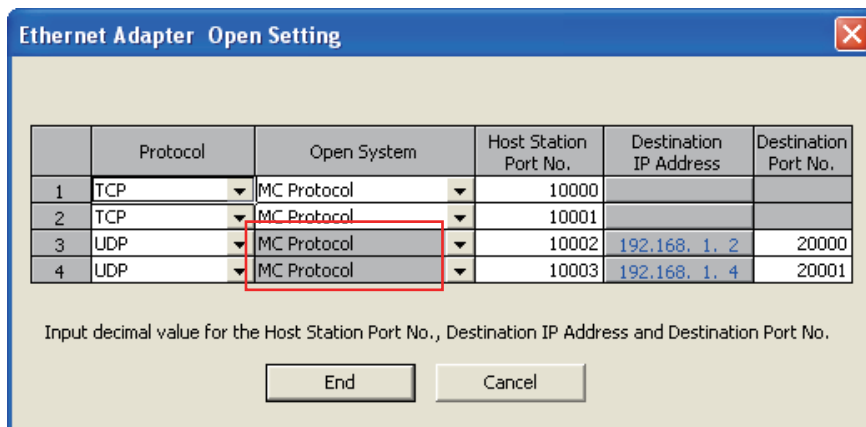

- 1 Introduction
- 2 Specification
- 3 System Configuration
- 4 Installation
- 5 Wiring
- 6 Introduction of Functions
- 7 Communication Using MC Protocol
- 8 The Operation of GX Works2
- 9 Troubleshooting
- A List of Special Devices

8.3 Time Setting

On the "Time Setting" screen, set the SNTP server IP address and others.

Click the [Time Setting] button on the "Ethernet Adapter" screen to display the screen below.

Setting	Description
SNTP Function Setting	Select whether to use the time setting function.
SNTP Server IP Address* ¹	SNTP Server IP Address is setting. [Setting range] <ul style="list-style-type: none"> • 0.0.0.1 to 223.255.255.254 (Decimal) • 00.00.00.01 to DF.FF.FF.FE (Hexadecimal)
Input Format	Select the input format used to set the SNTP server IP address. [Setting] <ul style="list-style-type: none"> • Decimal • Hexadecimal
Time Zone	Specify the time zone for synchronizing the time. [Setting] <ul style="list-style-type: none"> • GMT-12:00, GMT-11:00, GMT-10:00, GMT-9:00, GMT-8:00, GMT-7:00, GMT-6:00, GMT-5:00, GMT-4:00, GMT-3:30, GMT-3:00, GMT-2:00, GMT-1:00, GMT, GMT+1:00, GMT+2:00, GMT+3:00, GMT+3:30, GMT+4:00, GMT+4:30, GMT+5:00, GMT+5:30, GMT+5:45, GMT+6:00, GMT+6:30, GMT+7:00, GMT+8:00, GMT+9:00, GMT+9:30, GMT+10:00, GMT+11:00, GMT+12:00, GMT+13:00
Execute time setting at turn ON	Set whether or not time setting is executed when the power of the PLC main unit is turned ON.
On-error Action	Set whether processing is continued or stopped if an error occurs in the time setting executed when the power of the PLC main unit is turned ON.
Execution Interval* ²	Specify the time interval (1 to 1440 min) to execute time setting.
Execution Time* ²	Specify the time (in increments of 30 minutes) to execute time setting.

*1. Set the SNTP server IP address after consulting a network administrator.

*2. Only either one can be selected between "Execution Interval" and "Execution Time".

8.4 Log Record Setting

On the "Log Record Setting" screen, set the error log save destination and others. The user device (D, R) is used to save the error log, etc.

Click the [Log Record Setting] button on the "Ethernet Adapter" screen to display the screen below.

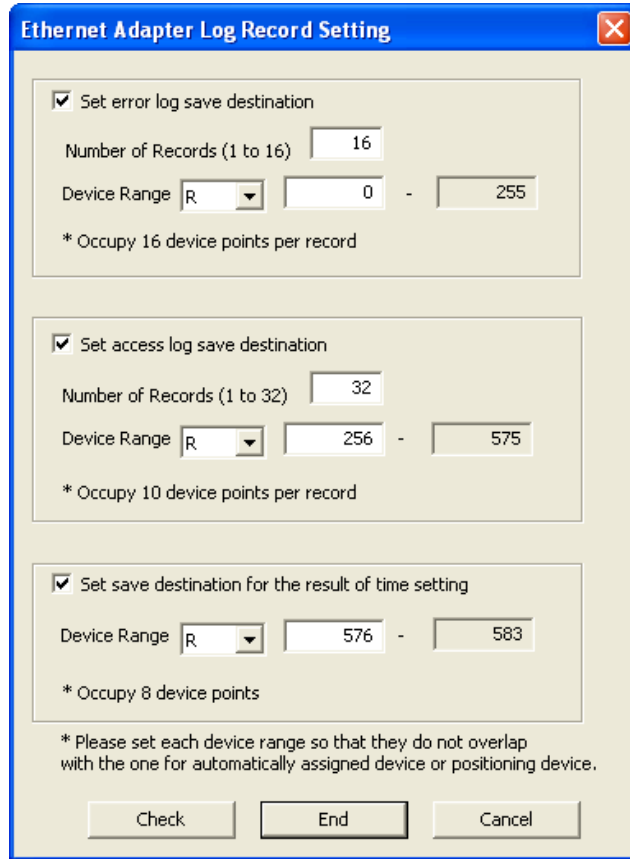

Setting		Description	
Set error log save destination		Error log is stored if checked.	
Error log	Number of Records	Specify the number of records in the error log within the range from 1 to 16. One record occupies devices 16 points.	
	Device Range	Head device type	Select the device type of the error log save destination between "D" and "R".
		Head device number	Set the head device number of the error log save destination.
		Last device number	The last device number in the occupied range calculated from the head device number and number of records is displayed.
Set access log save destination		Access log is stored if checked.	
Access log	Number of Records	Specify the number of records in the access log within the range from 1 to 32. One record occupies 10 points.	
	Device Range	Head device type	Select the device type of the access log save destination between "D" and "R".
		Head device number	Set the head device number of the access log save destination.
		Last device number	The last device number in the occupied range calculated from the head device number and number of records is displayed.
Set save destination for the result of time setting		Result of time setting is stored if checked.	
Save destination for the result of time setting (Device Range)	Head device type	Select the device type of the time setting result save destination between "D" and "R".	
	Head device number	Set the head device number of the time setting result save destination. 8 points are occupied from the head device number.	
	Last device number	The last device number in the occupied range calculated from the head device number is displayed.	

- 1 Introduction
- 2 Specification
- 3 System Configuration
- 4 Installation
- 5 Wiring
- 6 Introduction of Functions
- 7 Communication Using MFC Protocol
- 8 The Operation of GX Works2
- 9 Troubleshooting
- A List of Special Devices

8.5 Online Function

8.5.1 Designation of destination to be connected

When the FX PLC is connected using the Ethernet adapter, the following route is used.

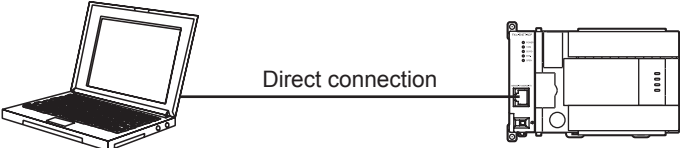
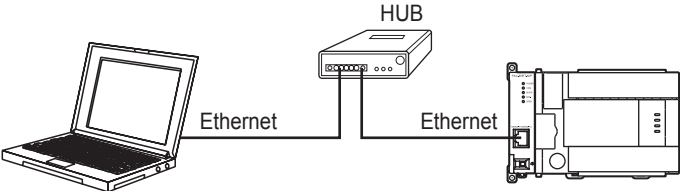
Personal computer side I/F	PLC side I/F	Other Station Setting Network	Connection pathname / Imaged figure / Explanation
Ethernet	CPU (Direct connection)	No Specification	<p>Direct connection of the PLC module for Ethernet board communication</p>  <p>Personal computer is connected directly to the Ethernet adapter with the LAN cable.</p>
Ethernet	CPU (HUB)	No Specification	<p>Connection of the PLC module via a hub for Ethernet board communication</p>  <p>Personal computer is connected to the Ethernet adapter via a hub. This route supports the find CPU function.</p>

1) Transfer Setup screen

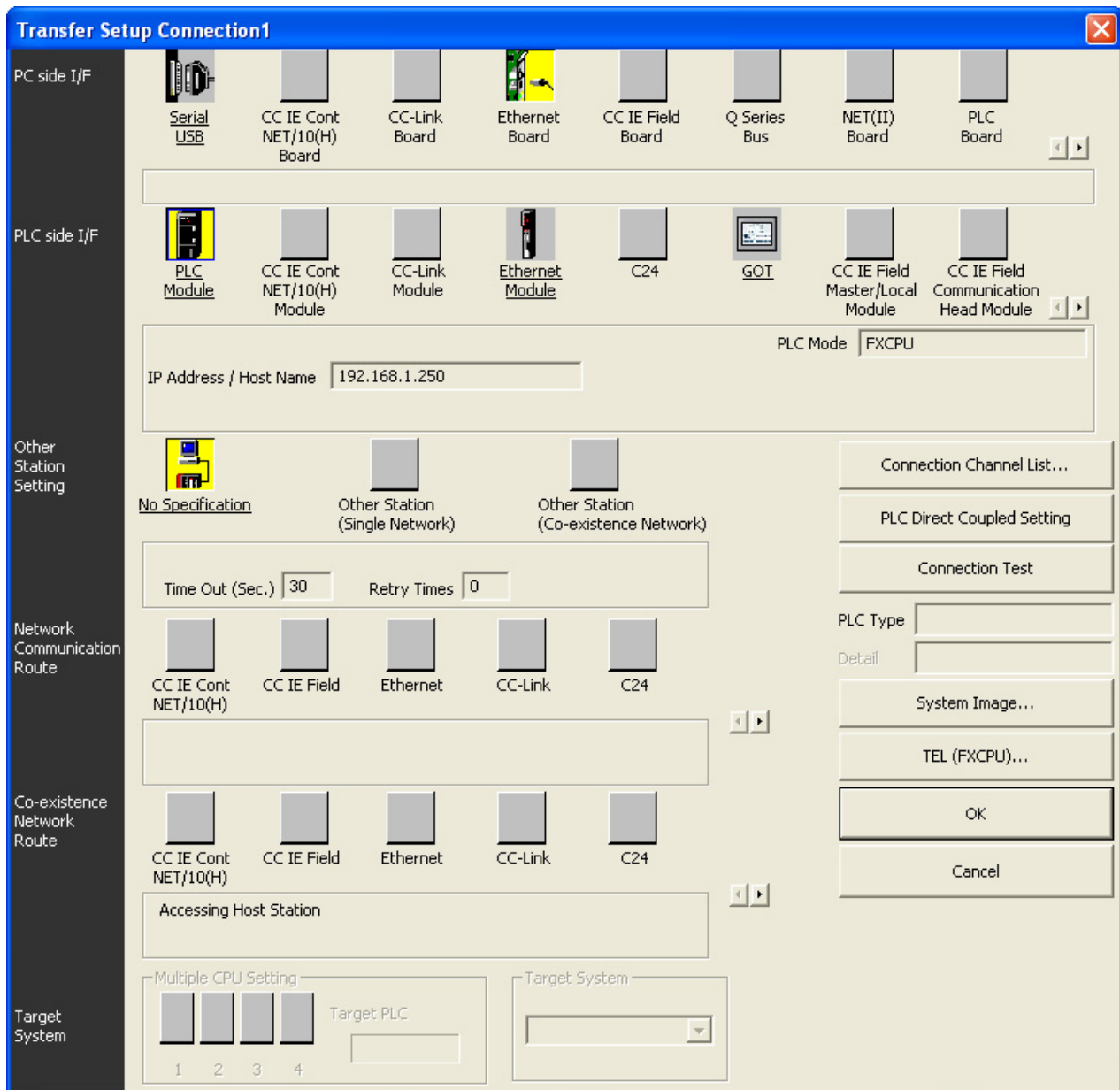

When connecting the FX PLC using the Ethernet adapter, set the following contents on the "Transfer Setup Connection" screen.

- a) PC side I/F
"Ethernet Board" is chosen.
- b) PLC side I/F
Double-click "PLC Module" to open the "PLC side I/F Detailed Setting of PLC Module" screen, and set details of the connection route. For description, refer to "2)" of following page.
- c) Other Station Setting
Double-click "No Specification", and set the "Check at Communication Time" and "Retry Times".

1

Introduction

2

Specification

3

System
Configuration

4

Installation

5

Wiring

6

Introduction of
Functions

7

Communication
Using
M/C Protocol

8

The Operation
of GX Works2

9

Troubleshooting

A

List of Special
Devices

2) PLC side I/F Detailed Setting of PLC Module screen

On the "PLC side I/F Detailed Setting of PLC Module" screen, set the connection type (direct connection to the Ethernet port or connection via a hub) and others. For connection via a hub, the method to directly enter the IP address and host name and the method to search for connected PLC units and select one from the list are available.

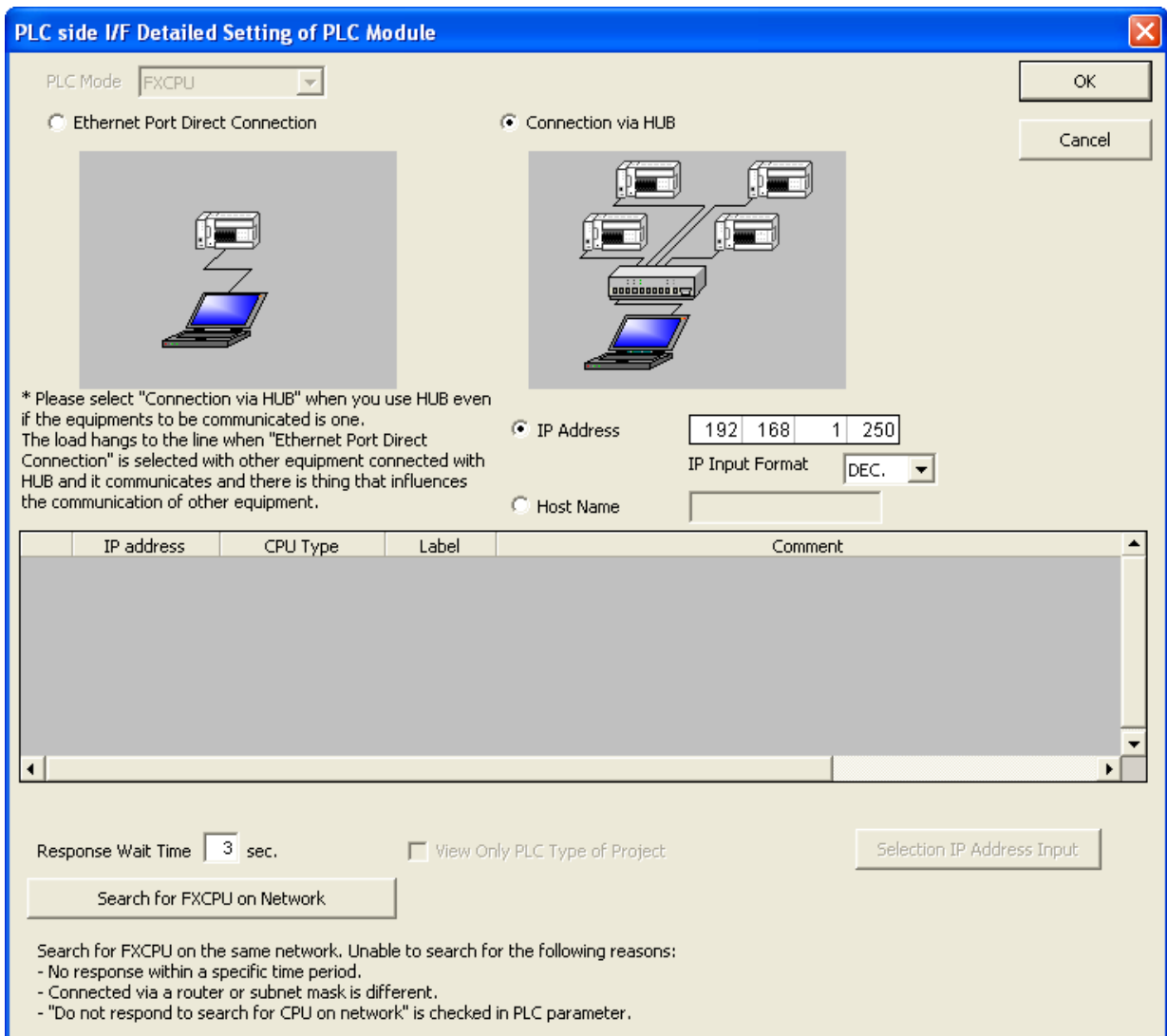

Explanation of the screen is shown below.

Setting	Description
PLC Mode	FXCPU is displayed.
Ethernet Port Direct Connection* ¹	Check this item to select direct connection to the Ethernet port.
Connection via HUB* ¹	Check this item to select connection via a hub.
IP Address* ²	When the item "Connection via HUB" is checked, specify the IP address of the connection destination. To enter the IP address, there is another method to search for FXCPU units on the network and select one from the list of found FXCPU units.
Host Name* ²	When the item "Connection via HUB" is checked, specify the host name of the connection destination.
IP Input Format	Specify the input format used to set the IP address. [Setting] <ul style="list-style-type: none"> • Decimal • Hexadecimal

Setting	Description
Connection CPU list	<p>This list shows the result of searching for FX PLC main units connected on the network.</p> <ul style="list-style-type: none"> • IP address : Displays the IP address of a found PLC (in decimal). • CPU type : Displays the CPU type of a found PLC. (Only "FX3U/FX3UC" is displayed.) • Label : Displays nothing because the FX PLC does not have any label. • Comment : Displays the PLC parameter, PLC name setting and title in up to 32 half-width characters. <p>It is possible to select (by double-clicking) a desired FX PLC from the list to enter the IP address.</p>
Response Wait Time	<p>Specify the response wait time in the find CPU function. [Setting range]</p> <ul style="list-style-type: none"> • 0 to 99
Find CPU (FXCPU Ethernet port) on Network	Click this button to execute search for FX PLC units connected on the network.*3
View Only PLC Type of Project	Check this item so that only the CPU type selected in the project is displayed in the list of CPU units found on the network.
Selection IP Address Input	Click this button to enter the IP address selected in the list of found CPU units to the "IP Address" input field.

- *1. Only one can be selected between "Ethernet Port Direct Connection" and "Connection via HUB".
- *2. Only one can be selected between "IP Address" and "Host Name".
- *3. When "*****" is displayed as the comment, the keyword setting in the main unit is set to "Read and write prohibited" or "All online operations prohibited".

8.5.2 Find CPU function

This function searches for CPU units connected to the Ethernet.

In GX Works2 searches for CPU units connected to the same hub as GX Works2 from "PLC Side I/F Detailed Setting of PLC Module", and displays the list of found CPU units. Select a desired CPU unit from the list to obtain its IP address.

1

Introduction

2

Specification

3

System Configuration

4

Installation

5

Wiring

6

Introduction of Functions

7

Communication Using M/C Protocol

8

The Operation of GX Works2

9

Troubleshooting

A

List of Special Devices

GX Works2 searches for FXCPU units, and displays the list of found FXCPU units.

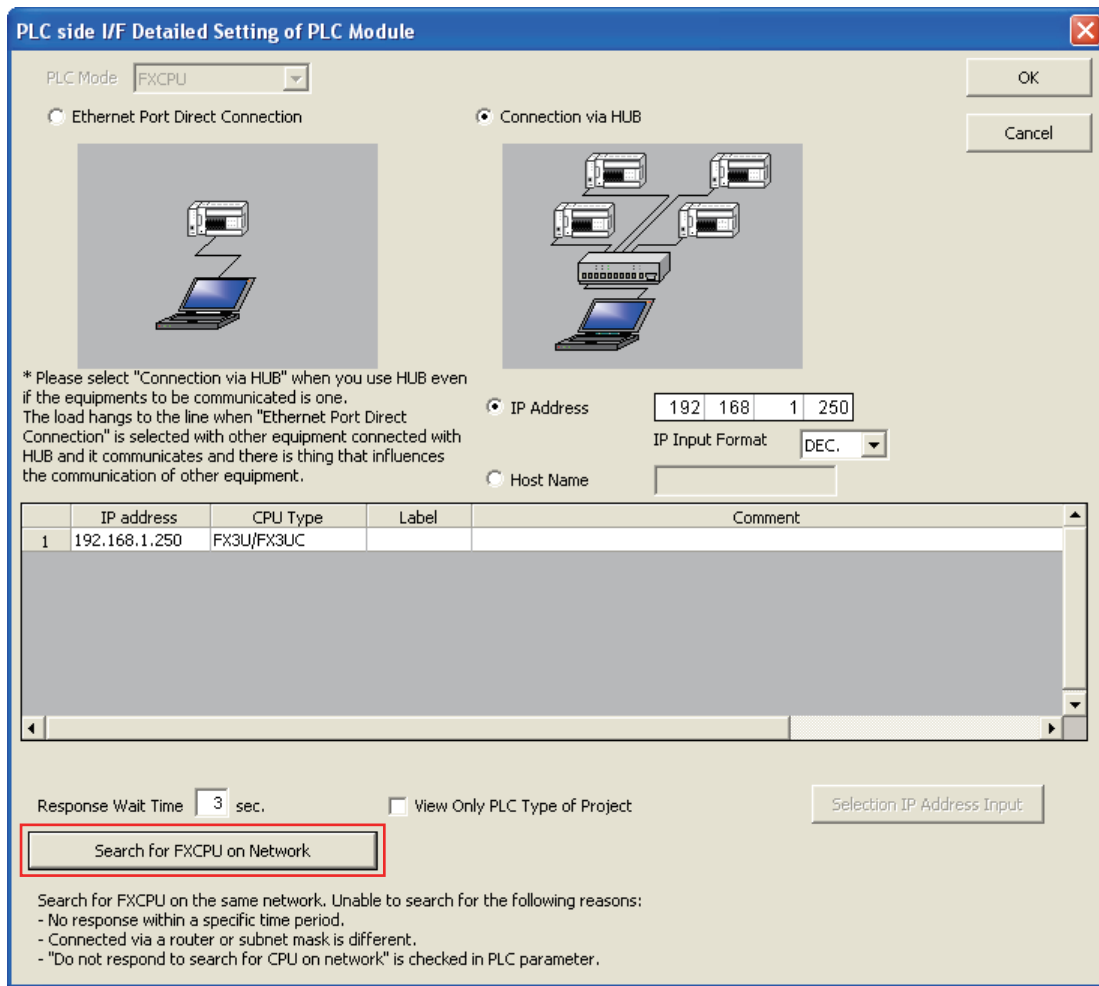

Check the item "Do not respond to search for CPU on network" to give no response to the search for CPU units on the network.

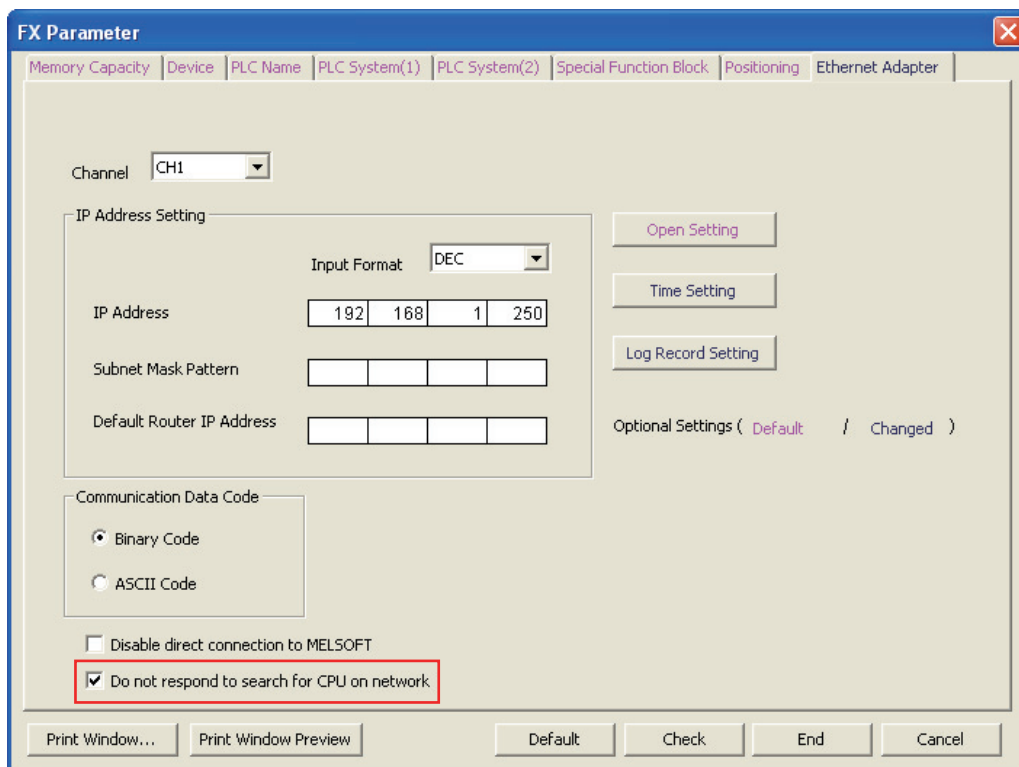

8.6 Ethernet Diagnostics

The Ethernet diagnostics function checks various setting status in the Ethernet adapter.

- Ethernet diagnostics function outline

When the Ethernet adapter is used, the Ethernet diagnostics function monitors and tests the following items.

Function	Description
Parameter status	IP address, Ethernet address, etc. are displayed.
Error history	Connection No., Error code, Port number, Date, Time, etc. are displayed.
Status of each connection (Access History)	<ul style="list-style-type: none"> Status of each connection : Host station port No., Destination IP address, Destination port No., Latest error code, etc. are displayed. Access History : Date, Time, Connection No., Destination IP address, etc. are displayed. ("Access History" is displayed together with "Status of each connection")
Status of each protocol	TCP packet number and UDP packet number are displayed.
Connection status	Full Duplex/Half Duplex, Connection status and 10BASE-T/100BASE-TX are displayed.
Time setting status	Latest time setting, Time required for response are displayed.
PING test	This test checks the presence of Ethernet modules on the Ethernet network whose initial processing is completed, or the presence of specified IP address.

For details, refer to Subsection 8.6.1 through Subsection 8.6.7.

Ethernet diagnostics screen is displayed from the "Diagnostics" → "Ethernet Diagnostics" menu.

Ethernet diagnostics screen

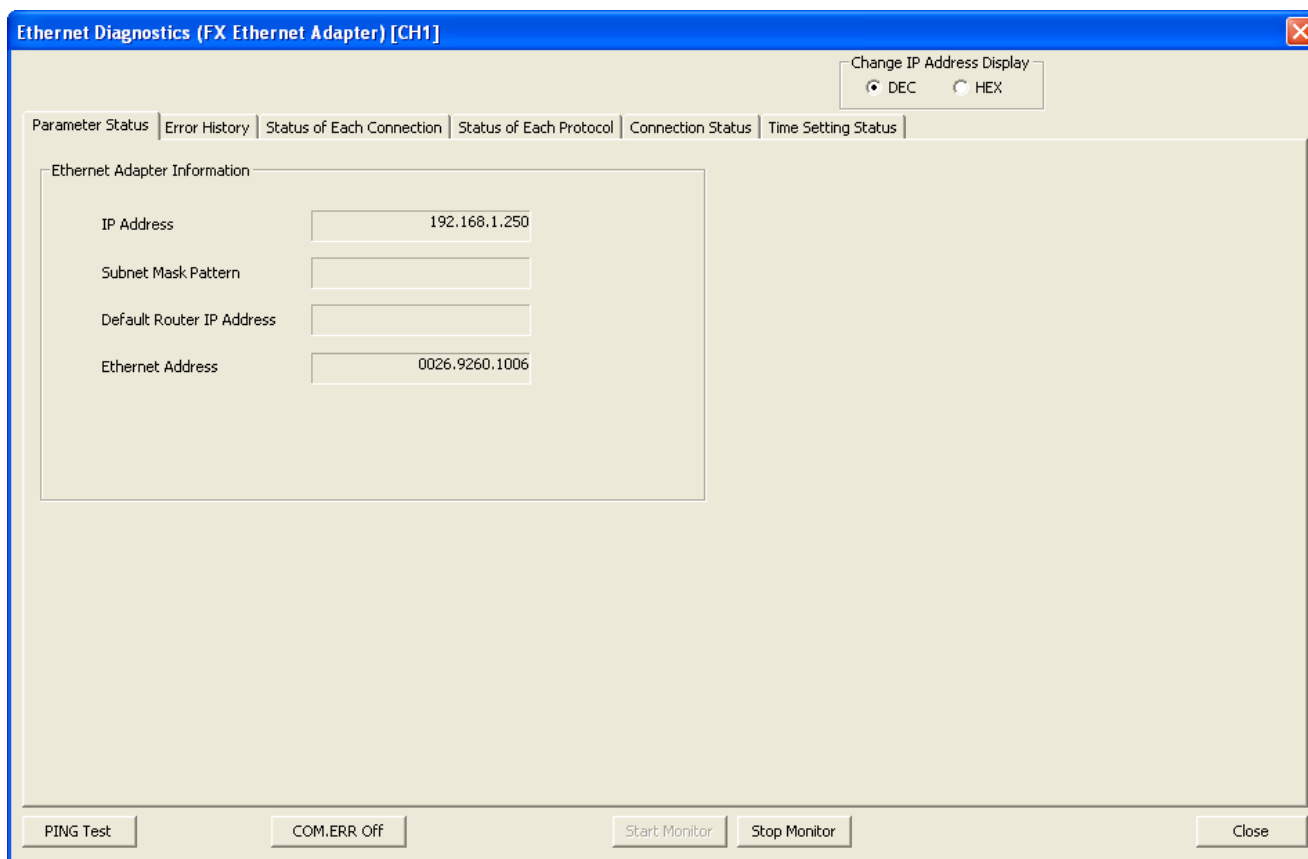

Item	Description
[Title bar]	Ethernet Diagnostics (FX Ethernet Adapter) [CH*] "[CH*]" indicates the channel being diagnosed (* = 1 or 2).
Change IP Address Display	Select the IP address notation on various tab screens between decimal and hexadecimal.
Various diagnostics function tabs	Each tab displays various information on the Ethernet adapter. Tabs are displayed in the following sequence. <ul style="list-style-type: none"> • Parameter Status • Error History • Status of Each Connection • Status of Each Protocol • Connection Status • Time Setting Status For details of each tab screen, refer to Subsection 8.6.1 through Subsection 8.6.7.
PING Test	Click this button to execute the PING test to the external device. For details, refer to Subsection 8.6.7.
COM.ERR Off	Click this button to turn OFF the flickering of the [ERR.] LED in the Ethernet adapter.
Start Monitor	Monitor is started.
Stop Monitor	Monitor is stopped.

8.6.1 Parameter status

Parameter status is monitored.

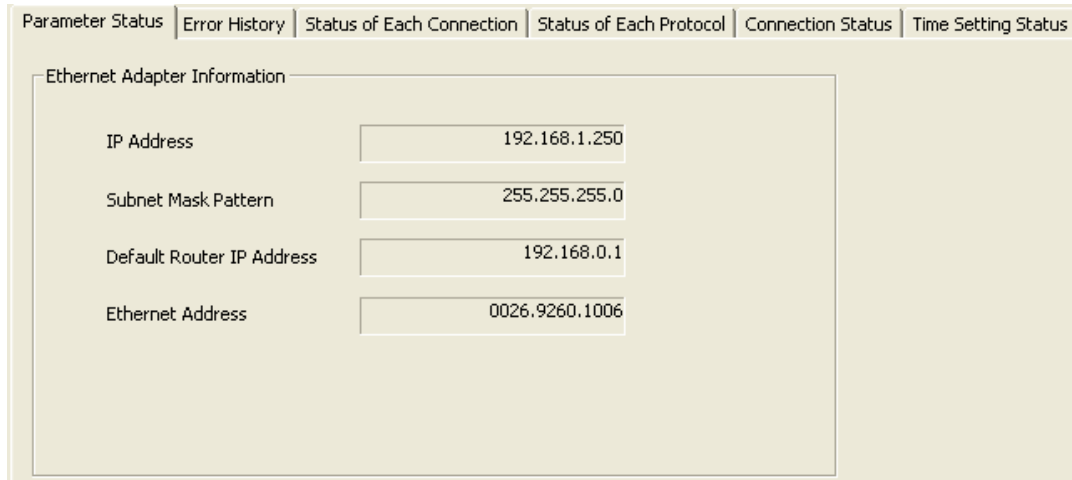

Item	Description
IP Address	IP address is displayed.
Subnet Mask Pattern	Subnet mask pattern is displayed.
Default Router IP Address	Default router IP address is displayed.
Ethernet Address	Ethernet address is displayed. Display is only in hexadecimal.

- 1** Introduction
- 2** Specification
- 3** System Configuration
- 4** Installation
- 5** Wiring
- 6** Introduction of Functions
- 7** Communication Using M/C Protocol
- 8** The Operation of GX Works2
- 9** Troubleshooting
- A** List of Special Devices

8.6.3 Status of each connection, Access History

Status of each connection and access history is monitored.

Parameter Status | Error History | **Status of Each Connection** | Status of Each Protocol | Connection Status | Time Setting Status

Status of Each Connection

Connection No./Function	Host Station Port No.	Destination IP Address	Destination Port No.	Latest Error Code	Protocol	Open System	TCP Status	Forced Deactivation Status
1	----	0.0.0.0	----	----	TCP	MELSOFT Connection	Disconnected	Allowed
2	----	0.0.0.0	----	----	TCP	MELSOFT Connection	Disconnected	Allowed
3	----	0.0.0.0	----	----	TCP	MELSOFT Connection	Disconnected	Allowed
4	----	0.0.0.0	----	----	TCP	MELSOFT Connection	Disconnected	Allowed
MELSOFT Direct Connection	----	0.0.0.0	----	----	----	----	----	Allowed

* Display format for Port No. is DEC.

Clear Latest Error Code | Disable Deactivation of Selected Row | Force Deactivation of Selected Row

Access History

	Year/Month/Day	Time	Connection No.	Protocol	Open System	Destination IP Address
Latest	2012-02-04	15:30:15	1	TCP	MELSOFT Connection	169.254.204.3
2	2012-02-04	15:30:10	1	TCP	MELSOFT Connection	169.254.204.3
3	2012-02-04	15:30:05	1	TCP	MELSOFT Connection	169.254.204.3
4	2012-02-04	15:30:00	1	TCP	MELSOFT Connection	169.254.204.3
5	2012-02-04	15:29:55	1	TCP	MELSOFT Connection	169.254.204.3
6	2012-02-04	15:29:50	1	TCP	MELSOFT Connection	169.254.204.3
7	2012-02-04	15:29:45	1	TCP	MELSOFT Connection	169.254.204.3
8	2012-02-04	15:29:40	1	TCP	MELSOFT Connection	169.254.204.3
9	2012-02-04	15:29:35	1	TCP	MELSOFT Connection	169.254.204.3
10	2012-02-04	15:29:30	1	TCP	MELSOFT Connection	169.254.204.3

* Unable to display history if Log Record Setting is not checked in Ethernet Adapter Setting of PLC parameter.

Clear History

Item and description of status of each connection.

Item	Description
Connection No./Function	Connection No. and MELSOFT Direct Connection is displayed
Host Station Port No.	Host station port No. is displayed.
Destination IP Address	Destination IP Address is displayed.
Destination Port No.	Destination port No. is displayed in decimal.
Latest Error Code	Latest Error Code is displayed in decimal.
Protocol	Protocol is displayed.
Open System	Open system is displayed
TCP Status	The connection status is displayed when TCP protocol is selected.
Forced Deactivation Status	Whether the forced deactivation status is allowed or rejected is displayed.
Clear Latest Error Code	Latest Error Code is cleared.
Disable Deactivation of Selected Row	This button cancels deactivation of the selected row.
Force Deactivation of Selected Row	This button deactivates the selected row.

Caution

While diagnosing Ethernet, MELSOFT connections opens/closes every time the display updates. Therefore, depending on the timing, it may not display the "TCP Status" as "Connecting."

1 Introduction

2 Specification

3 System Configuration

4 Installation

5 Wiring

6 Introduction of Functions

7 Communication Using M/C Protocol

8 The Operation of GX Works2

9 Troubleshooting

A List of Special Devices

Item and description of access history.

Item	Description
Year/Month/Day	Date when the error occurred is displayed.
Time	Time when the error occurred is displayed.
Connection No.	Connection No. (1 to 4) is displayed.
Protocol	Protocol is displayed.
Open System	Open system is displayed
Destination IP Address	Destination IP Address is displayed
Clear History	Error history is cleared.

Caution

- The history cannot be displayed when log record setting is not set up in the PLC parameters.
- When the open method is MELSOFT connection, or MELSOFT direct connection, multiple accesses made in a short period of time (less than 10 seconds) are not recorded in the access history.

8.6.4 Status of each protocol

Number of communication packets is monitored.

Item		Description
TCP Packet	Total Number of Receives	Total number of TCP packets received is displayed.
	Total Number of Sends	Total number of TCP packets sent is displayed.
UDP Packet	Total Number of Receives	Total number of UDP packets received is displayed.
	Total Number of Sends	Total number of UDP packets sent is displayed.
Clear the Status of Each Protocol		Packet number displays cleared.

- 1** Introduction
- 2** Specification
- 3** System Configuration
- 4** Installation
- 5** Wiring
- 6** Introduction of Functions
- 7** Communication Using M/C Protocol
- 8** The Operation of GX Works2
- 9** Troubleshooting
- A** List of Special Devices

8.6.5 Connection Status

Connection status (communicating status) is monitored.



Item	Description
Full Duplex/Half Duplex	Full Duplex or Half Duplex is displayed.
Connection Status	Connecting or Disconnected is displayed.
10BASE-T/100BASE-TX	10BASE-T or 100BASE-TX is displayed.

8.6.6 Time setting status

Time setting status is monitored.

Item	Description
Latest Time Setting	Displays the result Succeeded/Failed/Not Executed with respect to the latest time setting.
Execution Time	Execution time of time setting is displayed.
Time Required for Response	Execution time with the SNTP server (time information server) is displayed.
Execute Time Setting	Time setting is executed.

- 1** Introduction
- 2** Specification
- 3** System Configuration
- 4** Installation
- 5** Wiring
- 6** Introduction of Functions
- 7** Communication Using M/C Protocol
- 8** The Operation of GX Works2
- 9** Troubleshooting
- A** List of Special Devices

8.6.7 PING test

The PING test checks for the presence of Ethernet modules on the Ethernet network whose initial processing is completed, or the presence of specified IP address.

Execute the PING test to the Ethernet adapter to confirm the following items.

- Whether the Ethernet adapter (test target) is connected correctly to the network.
- Whether parameters for the Ethernet adapter are set correctly.
- Whether initial processing for the Ethernet adapter is completed normally.

Communication route

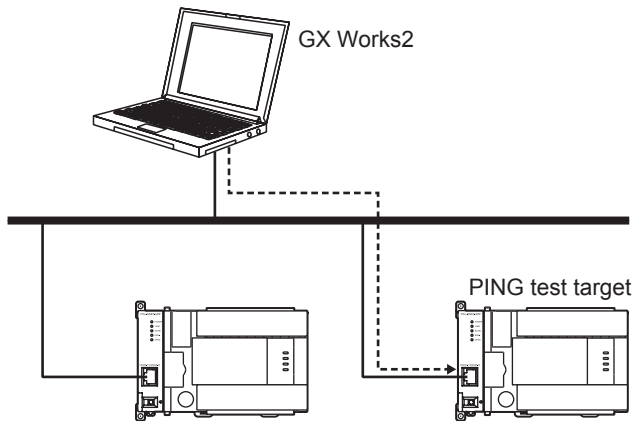

Caution

The PING test supports only the communication route via Ethernet (Ethernet connection), and does not support the communication route via the PLC (serial connection).

Display screen

"Diagnostics" → "Ethernet Diagnostics" → "PING Test" button is clicked.

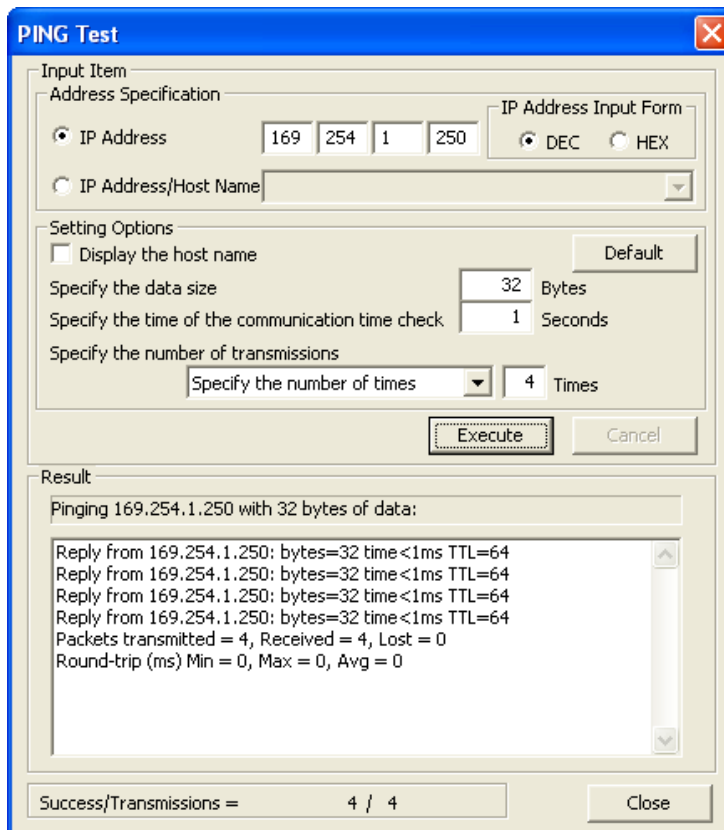

Item and description of the PING test screen

Item		Description	
Input item	Address Specification	IP Address	Set PING test target station IP address.
		IP Address Input Format	Input format of the IP address and decimal/hexadecimal are chosen.
		IP Address/Host Name	Set IP address or host name.
	Setting Options	Display the host name	When this item is checked, the host name corresponding to the IP address is displayed in the "Result" field.
		Specify the data size	Specify arbitrary size of the system data sent in the PING test. [Setting range] • 1 to 8192 byte (Default : 32 byte)
		Specify the time of the communication time check	The completed latency time of the PING test is specified. [Setting range] • 1 to 30 second (Default : 1 second)
		Specify the number of transmissions	Number of transmissions is specified. Or it executes until it is stopped. [Setting range] • 1 to 50 times (Default : 4 times)
		Default	Set default values to all settings in "Setting Options".
		Execute	PING test is executed.
		Cancel	PING test is stopped.
Result	Result	The result of the PING test is displayed.	
	Success/Transmissions	The total number of times a packet was sent and number of times it was successful in the PING test are displayed.	

[Address Specification]

Specify the PING test target station using the IP address or host name.

- When specifying the IP address
Select the IP address input format (decimal or hexadecimal).
Specify the IP address of the target station in accordance with the selected input format (decimal or hexadecimal).
- When specifying the host name
Specify the host name of the external device set in the "HOSTS" file in the personal computer where GX Works2 is installed or set in the DNS server.
It is possible to enter the IP address in the "IP Address/Host Name" input field.

[Setting Options]

Set details of the PING test. (It is not necessary to set this field when the initial value is used in each item.)

- Display the host name
Check this item when displaying the host name instead of the IP address of the PING test target station.
- Specify the data size
Specify the size of the system data sent in the PING test.
Setting range : 1 to 8192 byte (Default : 32 byte)
- Specify the time of the communication time check
Specify the time to wait for a response in the PING test.
Setting range : 1 to 30 second (Default : 1 second)
- Specify the number of transmissions
Specify the number of times the PING test is executed.

Select item	Description
Specify the number of times	The PING test is executed the specified number of times. Setting range : 1 to 50 times (Default : 4 times)
Execute till interrupting	The PING test is executed repeatedly until the [Cancel] button is clicked.

1

Introduction

2

Specification

3

System Configuration

4

Installation

5

Wiring

6

Introduction of Functions

7

Communication Using M/C Protocol

8

The Operation of GX Works2

9

Troubleshooting

A

List of Special Devices

[Description details of the result column]

- 1) Display of the PING test
 - a) Description of the IP address specification display
Pinging [IP address] with [Set size] bytes of data:
 - b) Example of IP address specification display
Pinging 192.168.0.3 with 32 bytes of data:
 - c) Description of the host name specification display
Pinging [Host name[IP address]] with [Set size] bytes of data:
 - d) Example of host name specification display
Pinging PLC1[192.168.0.3] with 32 bytes of data:
- 2) Description displayed on PING execution
 - IP address
 - Size of the received of the packet
 - Round trip time of the packet
 - Maximum lifespan of the packet
 - a) Description of the completion display
Reply from [IP address]:bytes=[Set size] time<1ms TTL=[Communication speed]
 - b) Example of completion display
Reply from 10.97.29.75:bytes=32 time<1ms TTL=64
 - c) Display when there is an error
Request timed out.
- 3) Description displayed on the reception end and the Cancel button click
 - Total packet transmission count
 - Success count
 - Failure count
 - Packet minimum round trip time
 - Packet maximum round trip time
 - Packet average round trip time

[Success/Transmissions]

The number of times of success and total number of times of a packet was sent are updated every time 1 packet is sent.

8.7 Print Function

This section explains the print content of each setting in the Ethernet adapter.

Caution

Printing Ethernet adapter information cannot be executed when "Channel" is set to "None" in the Ethernet adapter setting.

8.7.1 Printing from the menu

Select "Print" on the "Project" menu to display the batch print menu. "Ethernet adapter" is displayed on the "PLC Parameter" in the menu.

Printing item screen displayed when "Print" is selected on the "Project" menu.

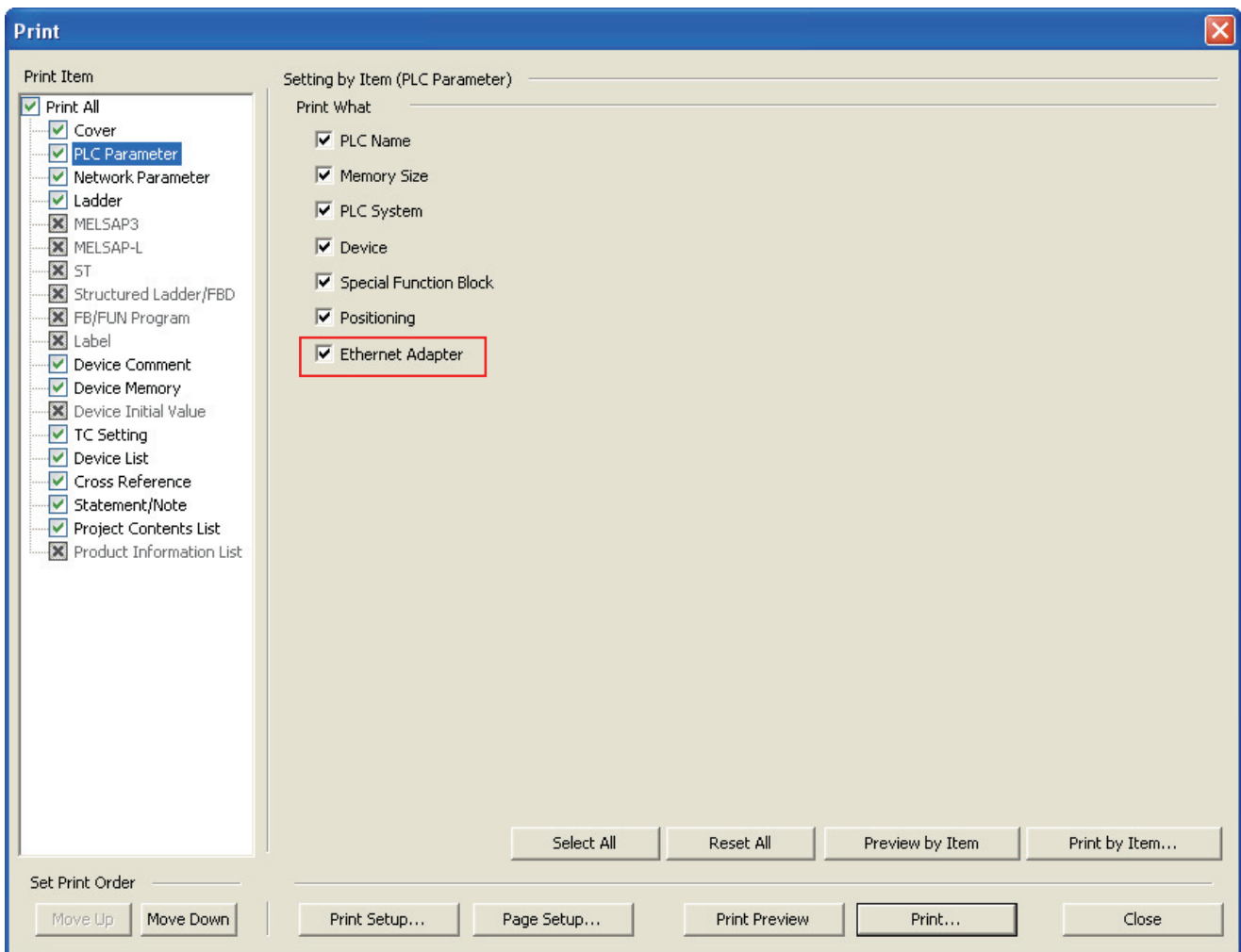

Caution

When "FX3U/FX3UC" is selected as the PLC type in the project, "Ethernet adapter" is valid (checked) as a PLC parameter printing target.

- 1 Introduction
- 2 Specification
- 3 System Configuration
- 4 Installation
- 5 Wiring
- 6 Introduction of Functions
- 7 Communication Using M/C Protocol
- 8 The Operation of GX Works2
- 9 Troubleshooting
- A List of Special Devices

Example of print preview image of the "Ethernet Adapter"

PLC Parameter	2/4/2012
Data Name : Ethernet Adapter	
Ethernet Adapter	
Channel	CH1
IP Address	192.168.1.250 (C0.A8.01.FA)
Subnet Mask Pattern	- (-)
Default Router IP Address	- (-)
Communication Data Code	Binary Code
Enable direct connection to MELSOFT	
Respond to search for CPU on network	

Example of print preview image of the "Ethernet Adapter Open Setting"

PLC Parameter	2/4/2012																														
Data Name : Ethernet Adapter																															
Ethernet Adapter																															
[Ethernet Adapter Open Setting]																															
	<table border="1"> <thead> <tr> <th></th> <th>Protocol</th> <th>Open System</th> <th>Host Station Port No.</th> <th>Destination IP Address</th> <th>Destination Port No.</th> </tr> </thead> <tbody> <tr> <td>1</td> <td>TCP</td> <td>MELSOFT Connection</td> <td></td> <td></td> <td></td> </tr> <tr> <td>2</td> <td>TCP</td> <td>MC Protocol</td> <td>1025 (0401)</td> <td></td> <td></td> </tr> <tr> <td>3</td> <td>TCP</td> <td>MELSOFT Connection</td> <td></td> <td></td> <td></td> </tr> <tr> <td>4</td> <td>TCP</td> <td>MELSOFT Connection</td> <td></td> <td></td> <td></td> </tr> </tbody> </table>		Protocol	Open System	Host Station Port No.	Destination IP Address	Destination Port No.	1	TCP	MELSOFT Connection				2	TCP	MC Protocol	1025 (0401)			3	TCP	MELSOFT Connection				4	TCP	MELSOFT Connection			
	Protocol	Open System	Host Station Port No.	Destination IP Address	Destination Port No.																										
1	TCP	MELSOFT Connection																													
2	TCP	MC Protocol	1025 (0401)																												
3	TCP	MELSOFT Connection																													
4	TCP	MELSOFT Connection																													

Example of print preview image of the "Ethernet Adapter Time Setting" (when the execution time is valid)

PLC Parameter	2/4/2012
Data Name : Ethernet Adapter	
Ethernet Adapter	
[Ethernet Adapter Time Setting]	
SNTP Function Setting	Use
SNTP Server IP Address	192.168.0.1 (C0.A8.00.01)
Time Zone	(GMT+9:00)
Do not execute time setting at turn ON	
On-error Action	Continue
Execution Time	12:00

Example of print preview image of the "Ethernet Adapter Time Setting" (when the execution interval is valid)

PLC Parameter	2/4/2012
Data Name : Ethernet Adapter Ethernet Adapter	
[Ethernet Adapter Time Setting]	
SNTP Function Setting	Use
SNTP Server IP Address	192.168.0.1 (C0.A8.00.01)
Time Zone	(GMT+9:00)
Do not execute time setting at turn ON	
On-error Action	Continue
Execution Interval	600 Minute

Example of print preview image of the "Ethernet Adapter Log Record Setting"

PLC Parameter	2/4/2012
Data Name : Ethernet Adapter Ethernet Adapter	
[Ethernet Adapter Log Record Setting]	
Set error log save destination	Valid
Number of Records	10
Device Range	R 0 - 159
Set access log save destination	Valid
Number of Records	32
Device Range	R 256 - 575
Set save destination for the result of time setting	Valid
Device Range	R 576 - 583

1

Introduction

2

Specification

3System
Configuration**4**

Installation

5

Wiring

6Introduction of
Functions**7**Communication
Using
MC Protocol**8**The Operation
of GX Works2**9**

Troubleshooting

AList of Special
Devices

8.7.2 Printing of the display screen

Click the [Print Window] button on the "Ethernet Adapter" tab of "FX Parameter" screen to print the display window.

Example of print preview image of the "Ethernet Adapter"

PLC Parameter				2/4/2012
Ethernet Adapter				
Channel	CH1			
IP Address	192.168.1.250	(C0.A8.01.FA)		
Subnet Mask Pattern	-	(-)		
Default Router IP Address	-	(-)		
Communication Data Code	Binary Code			
Enable direct connection to MELSOFT				
Respond to search for CPU on network				

Example of print preview image of the "Ethernet Adapter Open Setting"

PLC Parameter					2/4/2012
Ethernet Adapter					
[Ethernet Adapter Open Setting]					
	Protocol	Open System	Host Station Port No.	Destination IP Address	Destination Port No.
1	TCP	MELSOFT Connection			
2	TCP	MC Protocol	1025 (0401)		
3	TCP	MELSOFT Connection			
4	TCP	MELSOFT Connection			

Example of print preview image of the "Ethernet Adapter Time Setting" (when the execution time is valid)

PLC Parameter				2/4/2012
Ethernet Adapter				
[Ethernet Adapter Time Setting]				
SNTP Function Setting	Use			
SNTP Server IP Address	192.168.0.1	(C0.A8.00.01)		
Time Zone	(GMT+9:00)			
Do not execute time setting at turn ON				
	On-error Action Continue			
Execution Time	12:00			

Example of print preview image of the "Ethernet Adapter Time Setting" (when the execution interval is valid)

PLC Parameter	2/4/2012	
Ethernet Adapter		
[Ethernet Adapter Time Setting]		
SNTP Function Setting	Use	
SNTP Server IP Address	192.168.0.1	(C0.A8.00.01)
Time Zone	(GMT+9:00)	
Do not execute time setting at turn ON		
	On-error Action	Continue
Execution Interval	600	Minute

Example of print preview image of the "Ethernet Adapter Log Record Setting"

PLC Parameter	2/4/2012	
Ethernet Adapter		
[Ethernet Adapter Log Record Setting]		
Set error log save destination	Valid	
Number of Records	10	
Device Range	R	0 - 159
Set access log save destination	Valid	
Number of Records	32	
Device Range	R	256 - 575
Set save destination for the result of time setting	Valid	
Device Range	R	576 - 583

1

Introduction

2

Specification

3System
Configuration**4**

Installation

5

Wiring

6Introduction of
Functions**7**Communication
Using
MC Protocol**8**The Operation
of GX Works2**9**

Troubleshooting

AList of Special
Devices

9. Troubleshooting

This section explains the contents of the errors that may occur during communication between the Ethernet adapter and an external device as well as the troubleshooting procedures.

The following are methods for checking if there is an error on the Ethernet adapter side and the contents of the error.

Use one of the following methods to check if there is an error and its content, then take corrective actions.

- 1) Check using the display LED on the front of the Ethernet adapter (Refer to Section 9.1)
The display LED on/off status can be used to check if an error is occurring in the Ethernet adapter.
- 2) Check through GX Works2
GX Works2 can be used to check various conditions of the Ethernet adapter as well as the error code corresponding to the contents of the error occurring and to perform tests.
 - a) Ethernet diagnostics (Refer to Subsection 9.2.1)
 - PING test (Refer to Subsection 6.10.1)
 - Check the contents of the error using the error code (Refer to Subsection 9.3.1)
Confirm the contents of errors by obtaining the error code and referring to Subsection 9.3.1.

<Note>

When a line error occurs when devices manufactured by several manufacturers are connected, divide and determine the area where the line error has occurred using a line analyzer, etc.

9.1 How to Check Errors Using LED Displays

This section describes the errors that can be checked with the LED displays on the front of the Ethernet adapter.

9.1.1 Checking error display

The following can be checked with the LED displays on the front of the Ethernet adapter.

<Ethernet adapter LED>

<input type="radio"/> POWER
<input type="radio"/> 100M
<input type="radio"/> SD/RD
<input type="radio"/> ERR.
<input type="radio"/> OPEN

LED name	Status to check	Cause/corrective action
POWER	Does not turn ON when the power of the PLC main unit is turned ON.	The Ethernet adapter may not be connected correctly to the PLC main unit. Check the connection. When the connection is all right, the hardware may be defective. For repair, contact your local Mitsubishi Electric representative.
100M	Does not turn on	1) Using 10Mbps HUB <ul style="list-style-type: none"> • Initial processing. • Replace with 100Mbps HUB. 2) Using 100Mbps HUB <ul style="list-style-type: none"> • Check the connection of the connectors on the Ethernet side and the HUB side. • Replace the cable.

LED name	Status to check	Cause/corrective action
SD/RD	The [SD/RD] LED does not flash when sending and receiving data.	<ol style="list-style-type: none"> 1) [ERR.] LED turns on. <ul style="list-style-type: none"> - Remove the factors that turn on the [ERR.] LED. 2) Poor cable connection <ul style="list-style-type: none"> - Check the connection of the cable.*1 3) Local station IP address setting error <ul style="list-style-type: none"> - If the cable connection is all right, review each setting value of the local station IP address, router setting, and sub-net mask settings using GX Works2. 4) Program review is required <ul style="list-style-type: none"> - Review the sending program of the external device.
ERR.	Turns on after powering on the PLC (Ethernet adapter).	<ol style="list-style-type: none"> 1) Ethernet adapter parameter setting error <ul style="list-style-type: none"> - Check/correct the parameter setting values for Ethernet adapter using the GX Works2. 2) Ethernet adapter error (H/W error) <ul style="list-style-type: none"> - For repair, contact your local Mitsubishi Electric representative.
	Flicker after powering on the PLC (Ethernet adapter). Or flicker temporarily	<ol style="list-style-type: none"> 1) Check the contents of the error using the error codes stored by the error detection of the following and remove the causes. <ul style="list-style-type: none"> - Initial processing - Open processing - MC protocol communication processing - Other processing (processing for which error codes are stored in the error log area) 2) For error codes, refer to Subsection 9.3.1.
OPEN	Does not turn on	<ol style="list-style-type: none"> 1) Poor cable connection <ul style="list-style-type: none"> - Check the connection of the cable.*1 2) Program or parameter review is required <ul style="list-style-type: none"> - Check the program or parameters. - Check error contents with the diagnosis function of GX Works2.

*1. Confirm the completion for initial processing and check whether or not there is any problem in the cable connection and the Ethernet lines. Refer to Section 6.10, "Confirming the completion of the Initial Processing" for details on confirming the completion for initial processing.

9.1.2 How to turn off ERR. LED and to read/clear error information

It is possible to turn OFF the [ERR.] LED, read the error information and clear the error information using the Ethernet diagnostics function of GX Works2.

Click the [COM.ERR off] button on the Ethernet diagnostics screen to turn OFF the [ERR.] LED which was flickering.

For Ethernet diagnostics of GX Works2, refer to Section 8.6 and Section 9.2.

1

Introduction

2

Specification

3

System Configuration

4

Installation

5

Wiring

6

Introduction of Functions

7

Communication Using MC Protocol

8

The Operation of GX Works2

9

Troubleshooting

A

List of Special Devices

9.2 How to Check an Error Through GX Works2

Use the Ethernet diagnostics function of GX Works2 to check the Ethernet adapter status, parameter setting, communication status and error history.

9.2.1 Ethernet diagnostics

For Ethernet diagnostics of GX Works2, refer to Section 8.6.

For error code displayed on the error history, refer to Subsection 9.3.1.

Ethernet diagnostic screen

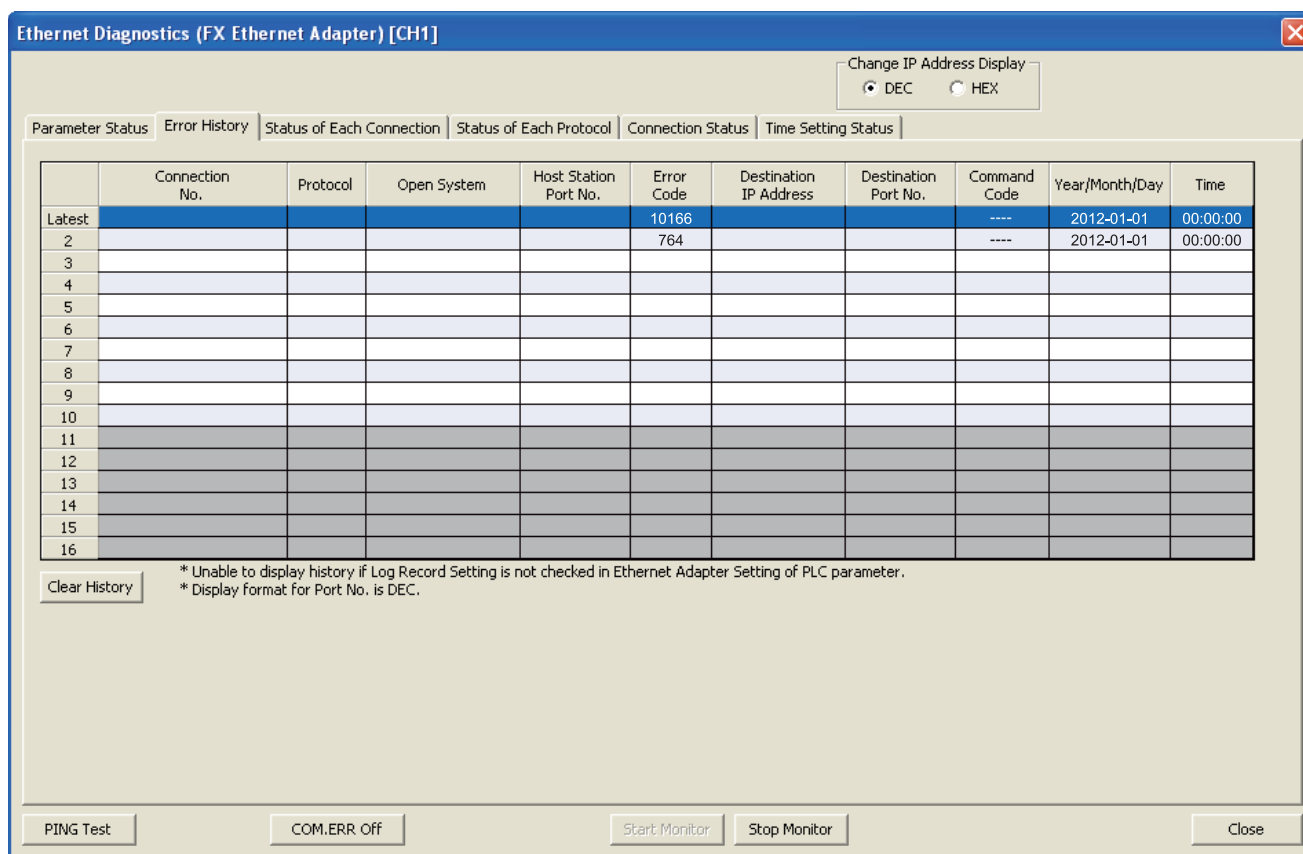

Ethernet diagnostic item

item	Description
Parameter Status	Ethernet adapter information such as its IP address is displayed.
Error History	Information on the error history is displayed.
Status of Each Connection	Information on the status of each connection is displayed.
Access History	Information on the access history is displayed.
Status of Each Protocol	Information on the status of each protocol is displayed.
Connection Status	Connection status is monitored.
Time Setting Status	Time setting status is monitored.
PING Test	Click this button to confirm the presence of Ethernet modules on the Ethernet network whose initial processing is completed, or the presence of specified IP address.
COM.ERR Off	[ERR.] LED which was flickering is switched off.

9.3 Error Code List

9.3.1 Error code of Ethernet communication

This section explains the error codes (abnormal codes) for errors that may occur in each processing when communicating between the Ethernet adapter and an external device as well as those generated by processing requests from the local station's FX series PLC.

Error Code List

Error Code (decimal)	Description	Corrective action	ERR. LED
21	An error is detected in the PLC main unit.	<ul style="list-style-type: none"> When an error has occurred in the PLC, take countermeasures in accordance with the contents of the error. Replace the PLC and/or Ethernet adapter. 	On
22			
101	ROM error	<ul style="list-style-type: none"> Check the connection status of connectors. Check whether the Ethernet adapter is used within the general specification range. Check whether the power capacity is sufficient. Check based on the manual of the Ethernet adapter and PLC main unit whether the hardware is in normal status. For repair, contact your local Mitsubishi Electric representative. If a problem cannot be solved by the above actions, confirm the operation/communication status when the error occurred and the error log in the Ethernet adapter. Contact your local Mitsubishi Electric branch office or representative, and report the confirmed information. 	
102			
103			
104			
120	An error is detected in the PLC main unit.	<ul style="list-style-type: none"> When an error has occurred in the PLC, take countermeasures in accordance with the contents of the error. Replace the PLC and/or Ethernet adapter. 	
750	Sum error has occurred in a parameter.	Set the parameter again, and start up the system again.	
751	The set value of a parameter is abnormal.	Check the version of the Ethernet adapter, PLC main unit and MELSOFT.	
752			
753	The set value of the Ethernet adapter IP address is wrong.	Correct the IP address. Set the class to "A", "B" or "C".	
756	The set value of the host station port No. is outside the allowable range when MELSOFT connection is specified. (Allowable range: 5556 only)	Correct the port No.	
757	The set value of the host station port No. is outside the allowable range when MC protocol (TCP or UDP) is specified. (Allowable range: 1025 to 5548 or 5560 to 65534)		
759	The set value of the external device IP address is wrong when MC protocol (UDP) is specified.	<ul style="list-style-type: none"> Correct the IP address. Set the class to "A", "B" or "C". Specify the default router IP address. 	
760	The set value of the external device port No. is outside the allowable range when MC protocol (UDP) is specified. (Allowable range: 1025 to 5548 or 5560 to 65534)	Correct the port No.	
761	The set value of the subnet mask field is outside the allowable range when the default router IP address is specified. (Allowable range: 192.0.0.0 to 255.255.255.252)	Correct the subnet mask.	
762	The set value of the subnet mask field is wrong when the default router IP address is specified. ("1" does not continue from the first bit.)		
763	The set value of the default router IP address is wrong when the default router IP address is specified.	Correct the IP address. Set the class to "A", "B" or "C".	

1

Introduction

2

Specification

3

System Configuration

4

Installation

5

Wiring

6

Introduction of Functions

7

Communication Using MC Protocol

8

The Operation of GX Works2

9

Troubleshooting

A

List of Special Devices

Error Code (decimal)	Description	Corrective action	ERR. LED
764	The Ethernet adapter IP address and default router IP address do not belong to the same network address when the default router IP address is specified.	Correct the IP address. Set the class to "A", "B" or "C".	On
765	The Ethernet adapter IP address and external device IP address do not belong to the same network address when the default router IP address is not specified.	<ul style="list-style-type: none"> Specify the default router IP address. Correct the external device IP address. Check whether the network address is correct. 	
766	The Ethernet adapter IP address and SNTP server IP address do not belong to the same network address when the default router IP address is not specified.	Correct the IP address. Set the class to "A", "B" or "C".	
767	The set value of the time zone is outside the allowable range when the SNTP function is used. (Allowable range: -12:00 to 13:00)	Correct the time zone setting.	
768	The set value of the SNTP server IP address is wrong when the SNTP function is used.	<ul style="list-style-type: none"> Correct the IP address. Set the class to "A", "B" or "C". Specify the default router IP address. 	
769	The set value of the execution time is outside the allowable range when the SNTP function is used. (Allowable range: 00:00 to 23:30)	Check the execution time setting.	
770	The set value of the execution interval is outside the allowable range when the SNTP function is used. (Allowable range: 1 to 1440)	Check the execution interval setting.	
771	The specified device type used to record the error log is outside the allowable range.	Check the device type setting.	
772	The set value of the number of records is outside the allowable range when the error log is recorded. (Allowable range: 1 to 16)	Check the number of records setting.	
773	The set value of the head device is outside the allowable range when the error log is recorded.	Check the device number setting.	
774	The specified device type used to record the access log is outside the allowable range.	Check the device type setting.	
775	The set value of the number of records is outside the allowable range when the access log is recorded. (Allowable range: 1 to 32)	Check the number of records setting.	
776	The set value of the head device is outside the allowable range when the access log is recorded.	Check the device number setting.	
777	The specified device type used to record the time setting result is outside the allowable range.	Check the device type setting.	
778	The set value of the head device is outside the allowable range when the time setting result is recorded.	Check the device number setting.	
779	The range of devices used to record various logs (error log, access log and time setting result) overlaps.	Correct the number of records and device number of various logs (error log, access log and time setting result).	
780	The host station port No. setting is wrong.	Correct the port No.	
815	Sending is disabled because a cable is disconnected or defective (wire breakage).	<ul style="list-style-type: none"> Check whether cables are connected correctly. Check the hub power supply. 	
850	Response from the SNTP server was not received.	<ul style="list-style-type: none"> Check whether the SNTP server is connected on the network. Correct the IP address. 	
911	A receive error occurred in TCP/IP communication.	<ul style="list-style-type: none"> Check operation of the external device. The line may be jammed with packets. Wait for a while, and execute sending again. Check whether cables are connected correctly. 	

Error Code (decimal)	Description	Corrective action	ERR. LED
912	A receive error occurred in UDP/IP communication.	<ul style="list-style-type: none"> Check operation of the external device. The line may be jammed with packets. Wait for a while, and execute sending again. Check whether cables are connected correctly. 	Flicker
1013	A send error occurred in TCP/IP communication.	<ul style="list-style-type: none"> Check operation of the external device. Check whether cables are connected correctly. 	
1014	A send error occurred in UDP/IP communication.	<ul style="list-style-type: none"> Check whether cables are connected correctly. 	
1015	Sending is disabled because a cable is disconnected or defective (wire breakage).	<ul style="list-style-type: none"> Check whether cables are connected correctly. Check the hub power supply. 	
1016	Sending is disabled because the communication line is closed.	<ul style="list-style-type: none"> Check operation of the external device. Check whether cables are connected correctly. 	
1117	The data length is beyond the allowable range.	<ul style="list-style-type: none"> Correct the data length. When the send data exceeds the specified quantity, divide it and send divided portions one by one. 	
2417		<ul style="list-style-type: none"> The line may be jammed with packets. Wait for a while, and execute sending again. 	
2550	Received ASCII code data cannot be converted into binary code when ASCII code communication is set in the operation setting in the Ethernet adapter.	<ul style="list-style-type: none"> Set binary code communication in the operation setting, start up the Ethernet adapter again, and execute communication again. Correct the send data from the external device, and send the corrected data. 	
2551	A specified device is wrong. (Unexpected device type.)	Correct the contents of request, and send the corrected contents to the Ethernet adapter.	
2552	A specified device is wrong. (Read/write of bit unit to a non-bit device.)	Correct the contents of request, and send the corrected contents to the Ethernet adapter. (Correct a subcommand, etc.)	
2553	A specified device is wrong. (An odd number is specified for access to C200 to C255.)	Correct the contents of request, and send the corrected contents to the Ethernet adapter.	
2554	A specified device is wrong. (The head device number is not a multiple of 16 when accessing bit devices in word units.)	Correct the contents of request, and send the corrected contents to the Ethernet adapter. (Correct a subcommand, etc.)	
2555	A specified device is wrong. (C200 to C255 are specified for word unit random write.)	Correct the contents of request, and send the corrected contents to the Ethernet adapter.	
2556	The number of read/write points is outside the allowable range.		
2557	The request for read/write exceeds the maximum address.		
2558	A specified command or subcommand is wrong.		
2559	A response was not received within the response monitoring timer value.	<ul style="list-style-type: none"> Make the response monitoring timer value longer. Check whether the PLC is operating normally. 	
2560	The specified PLC number is wrong.	Correct the PLC number.	
2650	HTTP request error	Check the HTTP version supported by the browser.	

1	Introduction
2	Specification
3	System Configuration
4	Installation
5	Wiring
6	Introduction of Functions
7	Communication Using M/C Protocol
8	The Operation of GX Works2
9	Troubleshooting
A	List of Special Devices

Error Code (decimal)	Description	Corrective action	ERR. LED
10166			
10167			
10168			
10169			
10853			
12650			
20154			
20155			
20156			
20159			
20353			
20354			
20356			
20357			
20359			
20360			
20361			
20363			
20364	System error (Communication with the PLC main unit failed.)	<ul style="list-style-type: none"> • Check the connection status of connectors. • When an error has occurred in the PLC, take countermeasures in accordance with the contents of the error. • Check the scan time in the PLC. • Check the timeout time (D8409 and D8429) for communication with the PLC main unit. • Replace the PLC and/or Ethernet adapter. 	On
20365			
20366			
20367			
20368			
20369			
20370			
20451			
20751			
20752			
20753			
20755			
20852			
20853			
20854			
20858			
20859			
21251			
21253			
21751			

9.3.2 End codes (completion codes) returned to an external device during data communication

This section explains the end codes (completion codes) that are added to responses when communicating using the MC protocol.

For more details on the error codes that are added to responses during communication using A compatible 1E frames through the MC protocol, refer to Subsection 9.3.3.

End code (hexadecimal)	Description	Corrective action
00H	Normal completion	-
50H	Codes for command/response type of subheader are not within the specifications (00 to 05H, 13 to 16H).	<ul style="list-style-type: none"> Check and correct command/ response type set by an external device. (The Ethernet adapter automatically adds command/ response type; the user does not need to set these.) Check and correct the data length.
54H	When "ASCII code communication" is selected in the [Communication data code settings] of operational setting parameters of GX Works2, ASCII code data that cannot be converted to binary code was received from an external device.	Check and correct the send data of the external device.
56H	Device designation from the external side is incorrect.	Correct the device designated.
57H	<ul style="list-style-type: none"> The number of points for a command designated by an external device exceeds the maximum number of processing points for each processing (number of processes that can be executed per communication). Head device number to the designated points exceeds the maximum addresses (device number). When performing batch read/write operations on C200 to C255, the number of device points was designated with an odd number. 	Correct the designated points or device number.
	<ul style="list-style-type: none"> Byte length of a command does not conform to the specifications. When writing data, the set number of points for data to be written is different from the number of points specified. 	Check the data length of the command and adjust the data setting.
58H	Head device number of a command designated by an external device is set outside the allowable range.	Designate the appropriate values within the range that are allowed for each processing.
	<ul style="list-style-type: none"> A word device is designated in a command for bit devices. The head number of bit devices is designated by a value other than a multiple of 16 in a command for word devices. 	Correct the command or the designated device.
5BH	<ul style="list-style-type: none"> The PLC and the Ethernet adapter cannot communicate. The PLC cannot process requests from an external device. 	Fix the faulty parts by referring to the abnormal codes appended to the end codes (refer to Subsection 9.3.3).
60H	Communication time between the Ethernet adapter and the PLC exceeded PLC monitoring timer value.	Increase the monitoring timer value.

9.3.3 Abnormal codes returned during communication using MC protocol

This section explains the abnormal codes (error codes) that are added to responses when communicating using MC protocol (An abnormal code is added only when an end code is "5B".)

For more details on the end codes (error codes) that are added to responses, refer to Subsection 9.3.2.

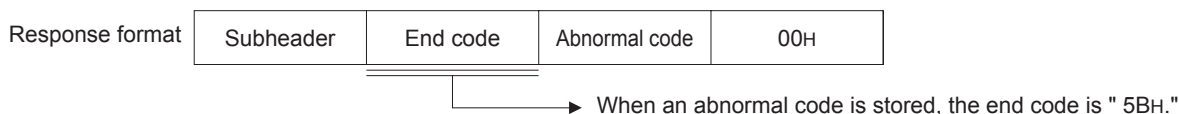

Error code (hexadecimal)	Error	Description of error	Corrective action
10H	PC number error	The PC number designated was not "FF".	Set the PC number to "FF".
11H	Mode error	Poor communication between the Ethernet adapter and the PLC <ul style="list-style-type: none"> After the Ethernet adapter receives a request successfully from an external device, the Ethernet adapter and the PLC could not communicate for some reason (noise, etc.). 	Communicate again. If an error occurs again, check noise, etc. and replace the Ethernet adapter, then communicate again.
18H	Remote error	Remote RUN/STOP not accessible. <ul style="list-style-type: none"> The PLC main unit status is error. 	Check whether the ERROR (ERR) LED of the PLC main unit is on or flickering. Check the contents of the error and remove the cause.

9.3.4 Communication error code inside the PLC

This subsection explains communication error codes stored inside the PLC (D8063 and D8438).

1) Error code list of channel 1 (D8063)

Error Code (decimal)	Operation of the PLC at time of error	Description of error	Corrective action
6301	Continues operation (RUN is possible)	Parity, overrun or framing error	Verify that the Ethernet adapter is installed correctly.
6302		Communication character error	
6303		Communication data sum check error	
6304		Communication data format error	
6305		Command error	
6309		N:N network setting error	N:N network setting is deleted. (N:N network setting in the channel 1 is invalid when the Ethernet adapter uses channel 1.)
6340	Special adapter connection error	Verify that the Ethernet adapter is installed correctly.	

2) Error code list of channel 2 (D8438)

Error Code (decimal)	Operation of the PLC at time of error	Description of error	Corrective action
3801	Continues operation (RUN is possible)	Parity, overrun or framing error	Verify that the Ethernet adapter is installed correctly.
3802		Communication character error	
3803		Communication data sum check error	
3804		Communication data format error	
3805		Command error	
3809		N:N network setting error	N:N network setting is deleted. (N:N network setting in channel 2 is invalid when the Ethernet adapter uses channel 2.)
3840	Special adapter connection error	Verify that the Ethernet adapter is installed correctly.	

9.4 Troubleshooting Flowchart

This section explains some simple troubleshooting procedures when the Ethernet adapter and an external device have communication problems in a flowchart format.*1

<POINT>

If trouble occurs when using the Ethernet adapter, check the block status, error status and others for the Ethernet adapter using the Ethernet diagnostic function of GX Works2 described in Section 8.6 and Subsection 9.2.1.

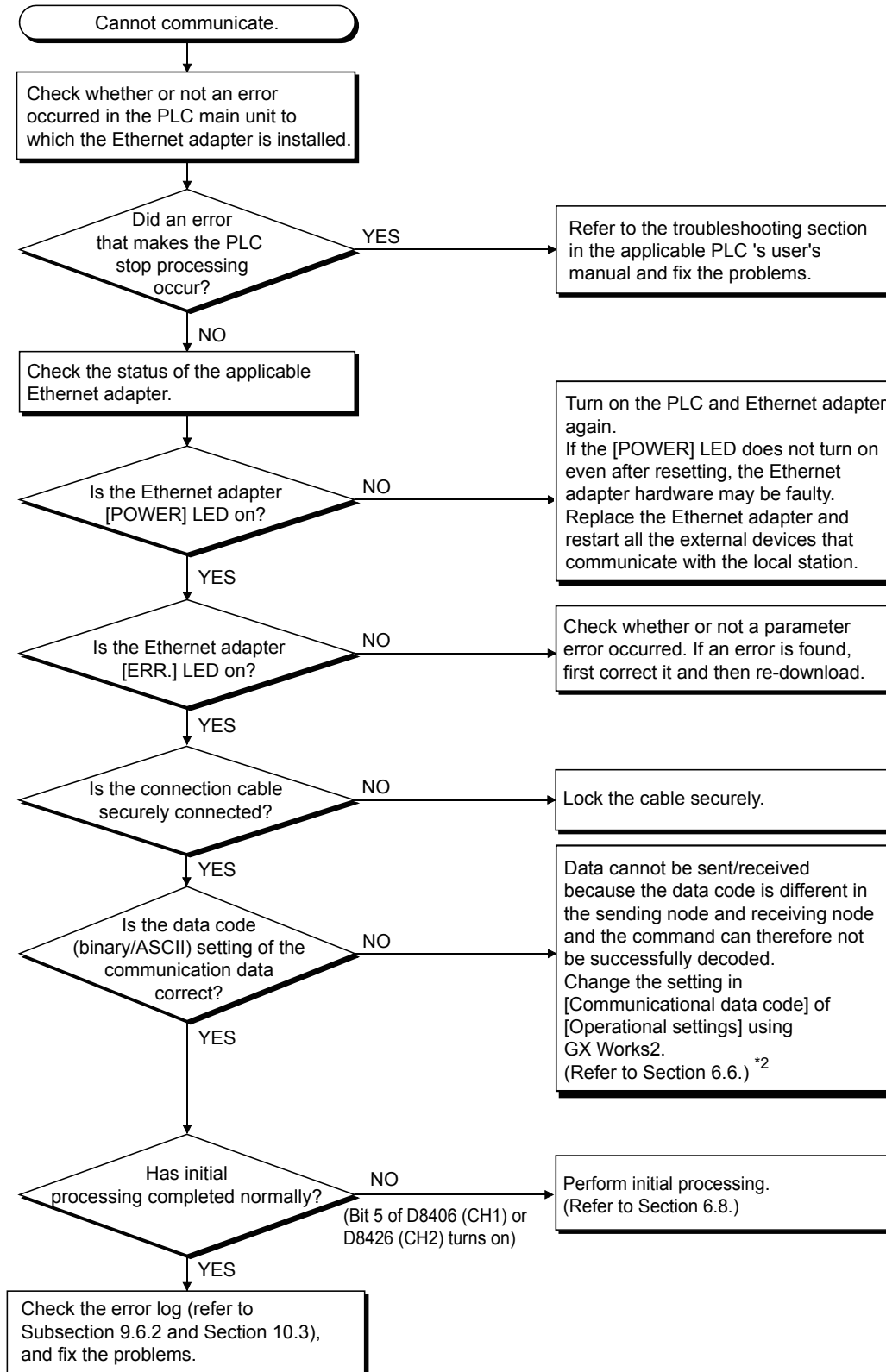

1	Introduction
2	Specification
3	System Configuration
4	Installation
5	Wiring
6	Introduction of Functions
7	Communication Using M/C Protocol
8	The Operation of GX Works2
9	Troubleshooting
A	List of Special Devices

- *1. If [ERR.] LED turns ON, refer to Section 9.1.
When an error is shown in the Error history (refer to Subsection 8.6.2) offered by the Ethernet diagnostics function of GX Works2, check the error code, and check the contents of the error and take countermeasures in accordance with Subsection 9.3.1.
- *2. Error codes not found in the error code list may be returned to the external device side if the communication data settings on the Ethernet adapter side (refer to Section 6.6) and the data code settings on the external device side are different.
The Ethernet adapter cannot decode commands correctly if data with different data codes is received.
The Ethernet adapter returns error responses according to the communication data code settings.

<POINT>

- 1) When the Ethernet adapter is replaced due to an error, reboot the following external devices and restart data communication:
(If the external device retains the Ethernet address, it may be impossible to continue communication because when a adapter is replaced the Ethernet address changes.)
Similarly, when the external device (personal computer, etc.) is replaced, restart the Ethernet adapter (PLC).
 - All external devices that communicated with the station whose Ethernet adapter was replaced.
 - All external devices that communicated with other stations' PLC via a station whose Ethernet adapter was replaced.
- 2) When connecting a device to the Ethernet adapter, see the following sections for the required devices and connection method:
Section 3.2: Devices Required for Network Configuration
Section 5.3: Connecting to the Network
- 3) When the Ethernet adapter often cannot receive messages sent from an external device (that is, when the error log is long), it may be that considerable load is applied on the Ethernet network due to data communication among connected devices.
To reduce the load to the Ethernet line, it is necessary to take corrective measures such as dividing the network or reducing the data transmission frequency.
Consult your network administrator and take appropriate measures.
- 4) If the ground terminals of the Ethernet adapter are not set, the communication line is closed (disconnected) due to the effects of noise, and as a result there may be no communication with external devices.

9.4.1 Errors in communication using MC protocol

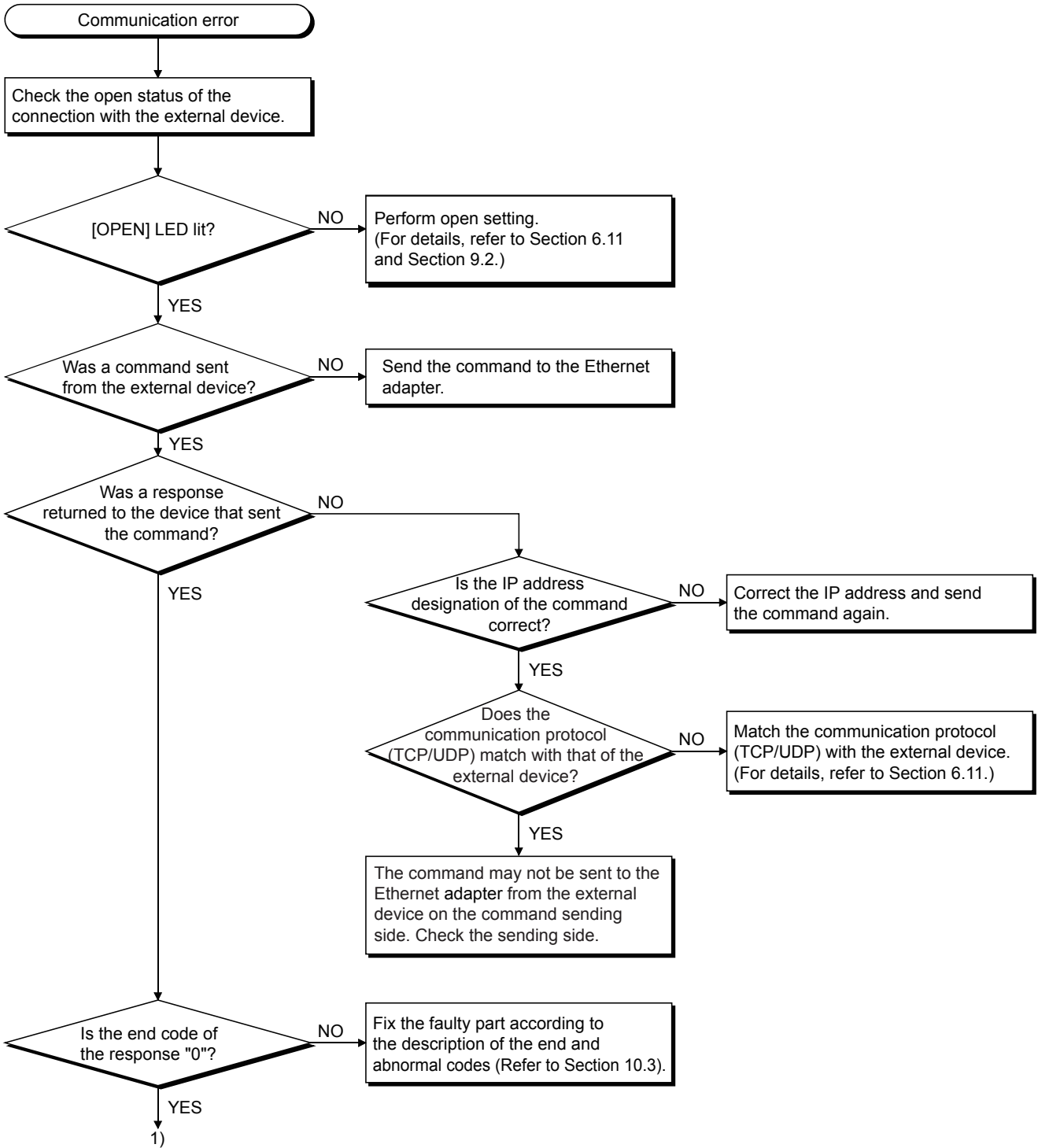

1	Introduction
2	Specification
3	System Configuration
4	Installation
5	Wiring
6	Introduction of Functions
7	Communication Using MC Protocol
8	The Operation of GX Works2
9	Troubleshooting
A	List of Special Devices

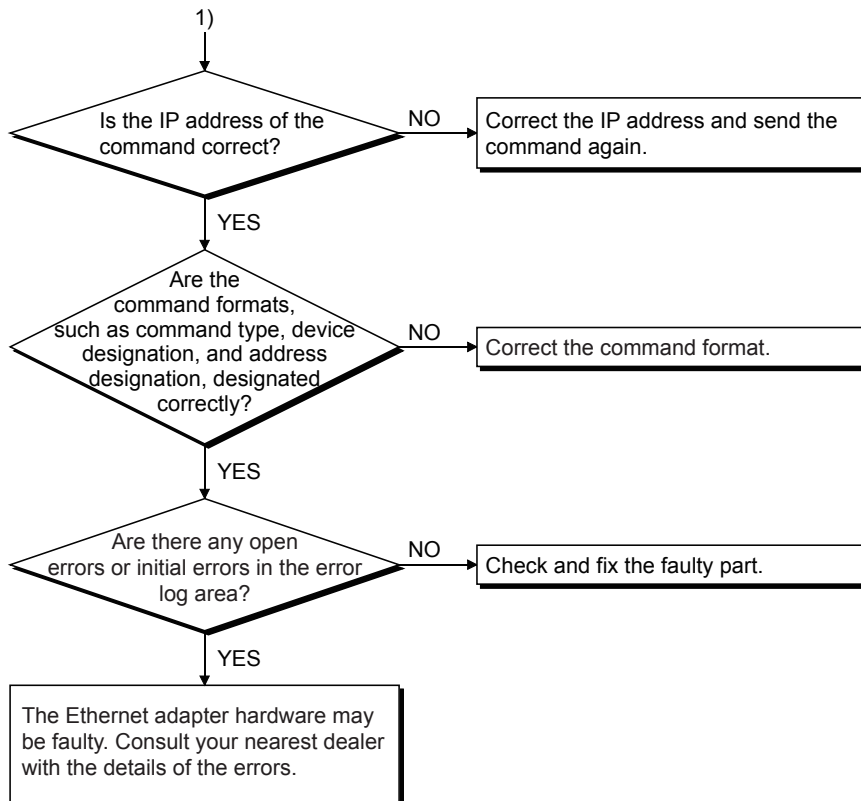
**<POINT>**

- If the external device communicates normally, the following conditions occur.
For TCP communication
When the external device's open status is complete, "OPEN" LED turns on.
For UDP communication
When external device communication is possible, "OPEN" LED turns on.

Appendix A: List of the Special Devices

The Ethernet adapter uses the following special auxiliary relays and special data registers of the PLC main unit.

The device number of used special auxiliary relays and special data registers varies depending on the connection channel in the Ethernet adapter.

Refer to the programming manual for special auxiliary relays and special data registers not shown below.

1. Special auxiliary relays

R : Read only W : Write only R/W : Read/Write is possible

Device number		Name	Description	R/W
CH1	CH2			
M8404	M8424	FX3U-ENET-ADP unit ready	Turns ON when the PLC main unit normally detects the Ethernet adapter.	R
M8406	M8426	Time setting execution ^{*1}	Remain ON while the Ethernet adapter is executing the time setting.	R
M8410	M8430	Not used	Since it is used by the system, it cannot be used by the user.	-
M8411	M8431	Execute time setting ^{*1}	Turn ON to make the Ethernet adapter execute the time setting.	R/W
M8412	M8432	Not used	Since it is used by the system, it cannot be used by the user.	-
M8413	M8433			
M8414	M8434			
M8415	M8435			
M8063	M8438	Error occurrence	Turns ON when an error occurs in the main unit.	R

*1. Used when the SNTP function setting is set to "Use" in the time setting parameters.

2. Special data registers

R : Read only W : Write only R/W : Read/Write is possible

Device number		Name	Description	R/W
CH1	CH2			
D8400	D8420	IP Address (Low-order)	Low-order portion of the set value of the IP address.	R
D8401	D8421	IP Address (High-order)	High-order portion of the set value of the IP address.	R
D8402	D8422	Subnet mask (Low-order)	Low-order portion of the set value of the subnet mask.	R
D8403	D8423	Subnet mask (High-order)	High-order portion of the set value of the subnet mask.	R
D8404	D8424	Default Router IP Address (Low-order)	Low-order portion of the set value of the default router IP address.	R
D8405	D8425	Default Router IP Address (High-order)	High-order portion of the set value of the default router IP address.	R
D8406	D8426	Status information	Stores the information on the Ethernet adapter status. b0 : INIT 1: Initial processing is completed normally. 0: - b2 : 100M/10M 1: 100Mbps 0: 10Mbps/un-connecting b3 : ERR. 1: Setting error 0: Normal setting b4 : COM.ERR. 1: Communication error 0: Normal communication b5 : 1: Initial processing completed abnormally. 0: - b7 : 1: Link signal ON 0: Link signal OFF b8 to b11 : Connection No.1 to 4 0: Closed 1: Open	R

Device number		Name	Description	R/W
CH1	CH2			
D8407	D8427	Connection condition of the Ethernet port	Stores the connection status of the Ethernet port in the Ethernet adapter. b10: Connection condition 0: The hub or external device is disconnected, or the cable is defective (wire breakage). 1: The hub or external device is connected. b14: Data transfer rate 0: 10BASE-T is adopted. 1: 100BASE-TX is adopted.	R
D8408	D8428	FX3U-ENET-ADP version	Stores the Ethernet adapter version.	R
D8409	D8429	PP communication timeout time	Stores the timeout time for PP communication between the Ethernet and the PLC main unit. (10 ms unit, default value =K300=3000 ms)	R
D8410	D8430	Connection forcible nullification	To be specified to force the connection in a user program to be invalid (Connection 1 to 4/MELSOFT/Direct connection). b 0: Connection 1 b 1: Connection 2 b 2: Connection 3 b 3: Connection 4 b10: MELSOFT communication port b13: MELSOFT direct connection 0: Valid (default value) 1: Invalid	R/W
D8411	D8431	Time setting functional operation result	Stores the time setting function operation result. 0: Not executed 1: Success -1: Failure	R
D8412	D8432	Host MAC address	Stores the MAC address (3 words in all).	R
D8413	D8433			R
D8414	D8434			R
D8416	D8436	Model code	Stores the model code of the Ethernet adapter. FX3U-ENET-ADP model code: K3000	R
D8417	D8437	Error code of the Ethernet adapter	Stores the error code detected by the Ethernet adapter. For details, refer to Subsection 9.3.1.	R
D8063	D8438	Error code	Stores the error code detected by the PLC main unit. For details, refer to Subsection 9.3.4.	R
D8419	D8439	Operation mode	Stores the status of the running communication function. The operation mode for FX3U-ENET-ADP: K11	R

Appendix B: Version Information

Appendix B-1 Version check method

1. Checking the nameplate

The Ethernet adapter version is indicated by "VERSION" on the label attached to the left side of the module when viewed from the front.

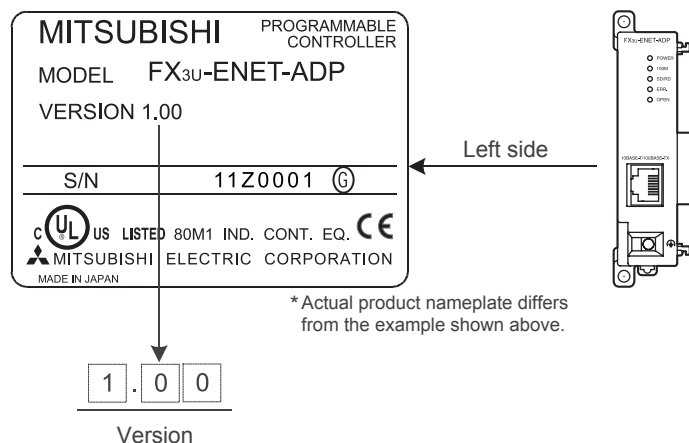

2. Checking the special data register

In the Ethernet adapter, users can obtain the Ethernet adapter version information by monitoring special data register D8408(CH1)/D8428(CH2) (decimal number).

Appendix B-2 Version upgrade history

The table below shows the version upgrade history for the Ethernet adapter.

Version	Contents of version upgrade
Ver.1.00	First product

Appendix C: Program Examples

The program examples presented in this section test the connection between the Ethernet adapter and an external device (personal computer) that is connected to the same Ethernet.

For each program, only the minimum programming that is required to perform the communication test is done. Modify the IP address, port number and other values according to your system configuration. In addition, handling for abnormalities may be added.

1) Receive processing of target device

A receive processing example on the target device side is shown below.

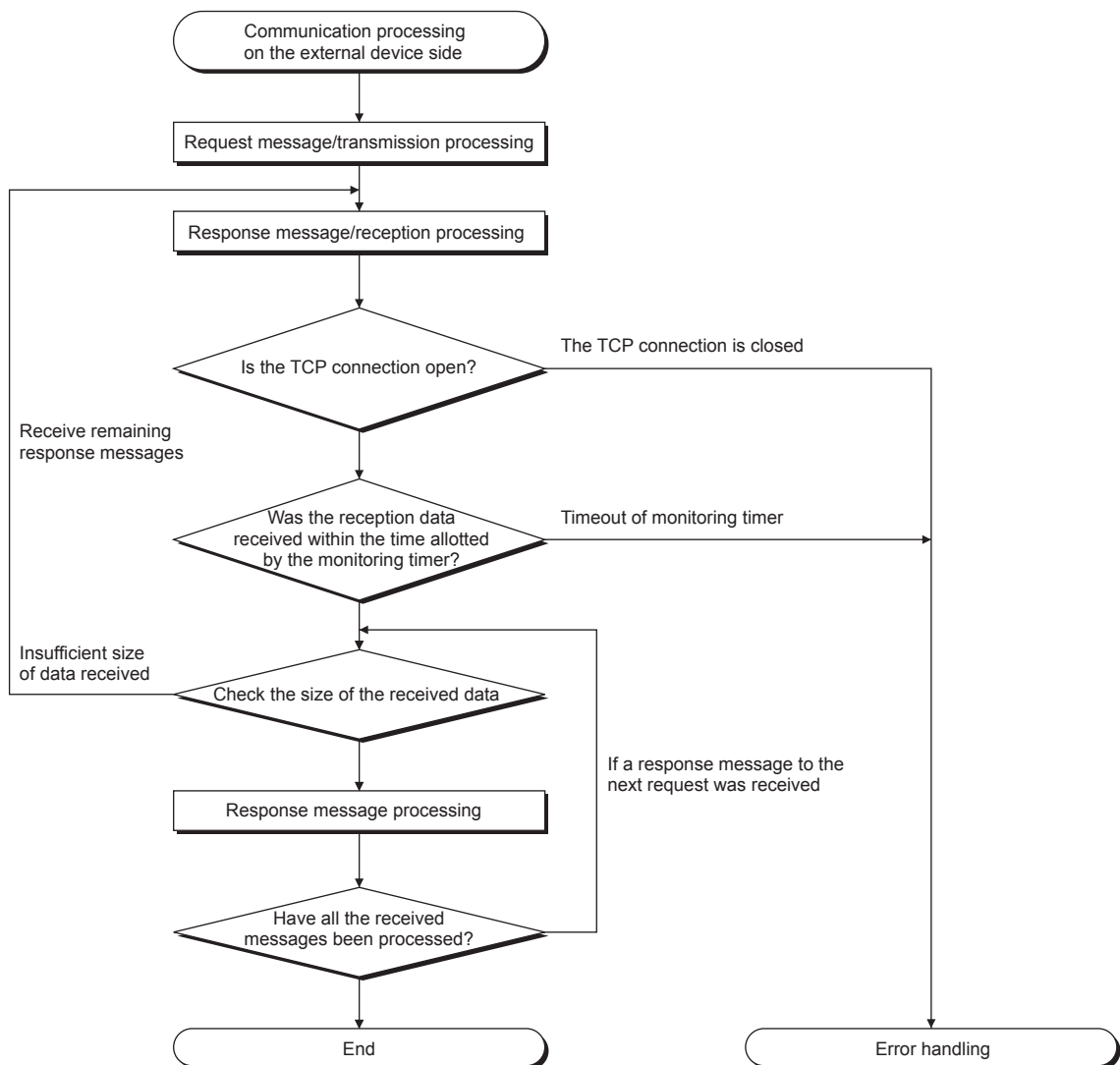

<Background>

For Ethernet communications, the TCP socket functions are used inside the personal computer. However, these functions do not have any limits. Therefore, when the "send" function is executed once to transmit data, the receiving end (node) needs to execute the "recv" function once or more in order to read the data ("send" and "recv" is not proportional to 1:1 execution). For this reason, the receiving procedure explained above, is required.

Appendix C-1 Program example for communication using MC protocol -1

The following explains a program example, its execution environment and the contents of data communication.

- 1) Execution environment of the program example
 - a) PLC side
 - Main unit of the Ethernet installed station :FX3U/FX3UC
 - Ethernet adapter No. : No.1
 - Ethernet adapter IP address : 172.16.56.99 (AC.10.38.63H)
 - Ethernet adapter port number : 10000
 - GX Works2 setting
 - Operational Settings :Refer to the following "3) GX Works2 setting a)"
 - Open settings : Refer to the following "3) GX Works2 setting b)"
 - b) External device side
 - Operation environment : Microsoft® Windows® 2000 Operating system
 - Ethernet interface board model name : WINSOCK compatible board
 - Library : WSOCK32.LIB
 - Software development environment : Microsoft® Corporation Visual C++® .NET
 - Ethernet address : Setting not required because the ARP function is available
 - IP address : Receive at Active open
 - Port number : Receive at Active open
 - c) Communication protocol : TCP/IP
- 2) Outline of the program example
 - a) Sequence program on the PLC side
Parameters are set from GX Works2.
(Sequence program is not required)
 - b) Program on the external device side
Executes the following read/write data communication with the PLC using the library mentioned above.
 - Write in word units (for 5 points from D0 to D4)
 - Read in word units (for 5 points from D0 to D4)
- 3) GX Works2 settings
Set the PLC parameters as follows.
 - a) Operation settings
Communication data code :ASCII
Initial timing : Always wait for OPEN (Communication possible at STOP time)
IP address : 172.16.56.99 (AC.10.38.63H)
 - b) Open settings
Protocol : TCP
Open system : Unpassive (MC)
Existence confirmation : No confirm
Local station Port No. : 10000
- 4) Program on the external device side
The program example of the external device shown below accesses the FX3U/FX3UC of the station in which the Ethernet adapter is installed.
When this program is executed, the contents of the following communication messages are displayed in sequence:
 - a) Batch write command message in word units
 - b) Batch write response message in word units
 - c) Batch read command message in word units
 - d) Batch read response message in word units

<Remarks>

- The following explains an outline of the compiling procedure for a program created using Microsoft Corporation Visual C++® .NET
 - 1) Start Visual C++® .
 - 2) Prepare for program creation.
Select "New Project" from the project tab, select "Win32 console project", and create an empty project with the name "ENETSAMP".
 - 3) Add ENETSAMP.C to the project and create a program.
(See the program example on the next page.)
 - 4) Compile the created file from the compile screen of the build menu.
 - 5) From the project menu property setting screen, add WSOCK32.LIB to the linker addition dependency files.
 - 6) Create an executable file (ENETSAMP.EXE) on the build screen of the build menu.
 - 7) End Visual C++® .NET.
 - 8) Execute ENETSAMP.EXE.
- Outline of the procedure for calling the socket routine

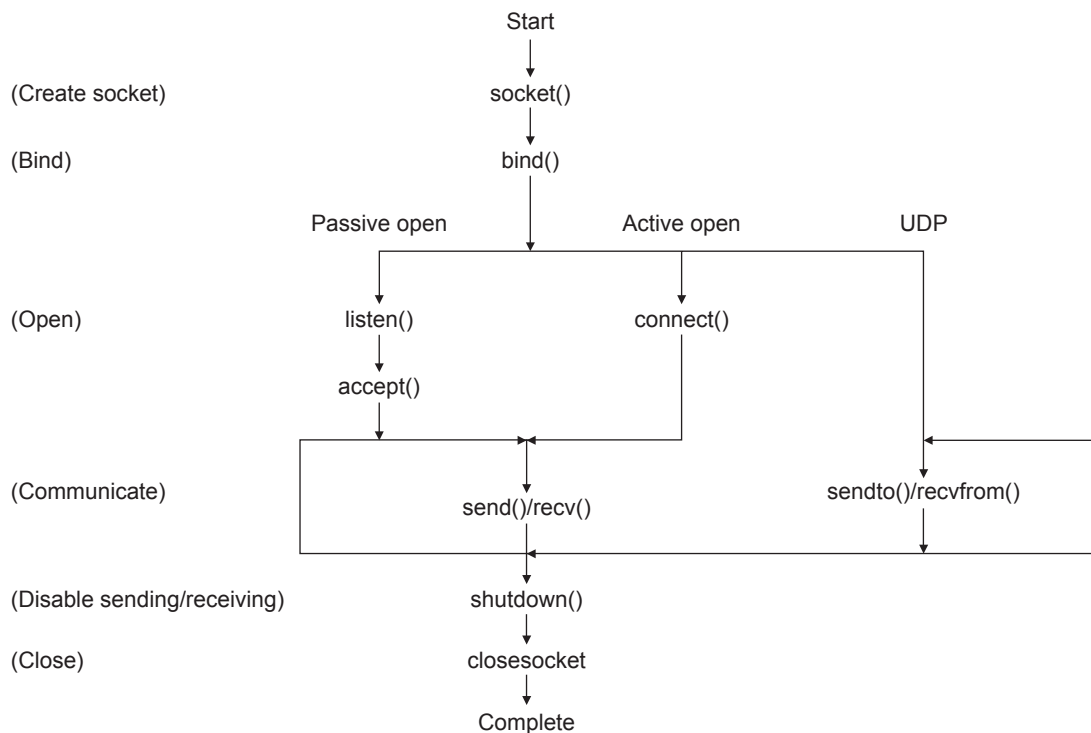

```

/ ***** /
/ **           ** /
/ ** Sample program           ** /
/ **           ** /
/ ** This program is a sample program to conduct a connection test between the Ethernet adapter and target device. This program accesses the data register (D) of the PLC main unit installed together with the Ethernet adapter.
/ **           ** /
/ ** Copyright(C) 2011 Mitsubishi Electric Corporation All Rights Reserved
/ **           ** /
/ ***** /

#include <stdio.h>
#include <winsock.h>
#define FLAG_OFF 0 // Completion flag OFF
#define FLAG_ON 1 // Completion flag ON
#define SOCK_OK 0 // Normal completion
#define SOCK_NG -1 // Abnormal completion
#define BUF_SIZE 4096 // Receive buffer size
#define ERROR_INITIAL 0 // Initial error
#define ERROR_SOCKET 1 // Socket creation error
#define ERROR_BIND 2 // Bind error
#define ERROR_CONNECT 3 // Connection error
#define ERROR_SEND 4 // Send error
#define ERROR_RECEIVE 5 // Receive error
#define ERROR_SHUTDOWN 6 // Shutdown error
#define ERROR_CLOSE 7 // Line close error
//Definitions for checking the receiving sizes
// #define RECV_ANS_1 4 // Receiving size of response message in reply to device write (1E frame)
// #define RECV_ANS_2 24 // Receiving size of response message in reply to device read (1E frame)

typedef struct sck_inf{
    struct in_addr my_addr;
    unsigned short my_port;
    struct in_addr FX_IP_addr;
    unsigned short FX_port;
};

int nErrorStatus; // Error information storage variable
int Dmykeyin; // Dummy key input
int Closeflag; // Connection completion flag
SOCKET socketno;

int main()
{
    WORD wVersionRequested=MAKEWORD(1,1); // Winsock Ver 1.1 request
    WSADATA wsaData;
    int length; // Communication data length
    unsigned char s_buf[BUF_SIZE]; // Send buffer
    unsigned char r_buf[BUF_SIZE]; // Receive buffer
    int rbuf_idx; // Receive data storage head index
    int recv_size; // Number of receive data
    struct sck_inf sc;
    struct sockaddr_in hostdata; // External device side data
    struct sockaddr_in FX3UENETADP; // Ethernet adapter side data
    void Sockerror(int); // Error handling function
    unsigned long ulCmdArg ; // Non-blocking mode setting flag

```

```

sc.my_addr.s_addr=htonl(INADDR_ANY);           // External device side IP address
sc.my_port=htons(0);                          // External device side port number
sc.FX_IP_addr.s_addr=inet_addr("172.16.56.99"); // Ethernet adapter side IP address
                                                // (AC103863h)
sc.FX_port=htons(10000);                      // Ethernet adapter side port number
Closeflag=FLAG_OFF;                          // Connection completion flag off
nErrorStatus=WSAStartup(wVersionRequested,&wsaData); // Winsock Initial processing
if (nErrorStatus!=SOCK_OK) {
    Sockerror(ERROR_INITIAL);                 // Error handling
    return (SOCK_NG);
}
printf ("Winsock Version is %ld.%ld\n",HIBYTE(wsaData.wVersion),LOBYTE(wsaData.wVersion));
printf ("FX3U-ENET-ADP Test Start\n");
socketno=socket(AF_INET,SOCK_STREAM,0);       // Create socket for TCP/IP
if (socketno==INVALID_SOCKET){
    Sockerror (ERROR_SOCKET);                // Error handling
    return(SOCK_NG);
}
hostdata.sin_family=AF_INET;
hostdata.sin_port=sc.my_port;
hostdata.sin_addr.s_addr=sc.my_addr.s_addr;
if(bind(socketno,(LPSOCKADDR)&hostdata,sizeof(hostdata))!=SOCK_OK){
    // Bind
    Sockerror(ERROR_BIND);                   // Error handling
    return(SOCK_NG);
}
FX3UENETADP.sin_family=AF_INET;
FX3UENETADP.sin_port=sc.FX_port;
FX3UENETADP.sin_addr.s_addr=sc.FX_IP_addr.s_addr;
if(connect(socketno,(LPSOCKADDR)&FX3UENETADP,sizeof(FX3UENETADP))!=SOCK_OK){
    // Connection (Active open)
    Sockerror(ERROR_CONNECT);                // Error handling
    return(SOCK_NG);
}
Closeflag=FLAG_ON;                           // Connection completion flag ON
// Go to non-blocking mode
ulCmdArg = 1;
ioctlsocket(socketno, FIONBIO, &ulCmdArg);   // Set to non-blocking mode
strcpy(s_buf, "03FF000A4420000000000500112233445566778899AA");
// D0 to D4 batch write request (1E frame)
length=(int)strlen(s_buf);
if(send(socketno,s_buf,length,0)==SOCKET_ERROR){ // Data sending
    Sockerror(ERROR_SEND);                  // Error handling
    return (SOCK_NG);
}
printf("\n send data\n%s\n",s_buf);

// Perform receiving size check and receiving processing simultaneously
rbuf_idx = 0;                                // Receive data storage head index initialization
recv_size = 0;                               // Initialize the number of receive data
while(1) {
    length = recv(socketno, &r_buf[rbuf_idx], (BUF_SIZE - rbuf_idx), 0);
    // Response data receiving
    if(length == 0) {
        Sockerror(ERROR_RECIEVE);           // Is connection cut off?
        return (SOCK_NG);                  // Error handling
    }
}

```

```

        if(length == SOCKET_ERROR) {
            nErrorStatus = WSAGetLastError();
            if(nErrorStatus != WSAEWOULDBLOCK) {
                Sockerror(ERROR_RECIEVE);           // Error handling
                return (SOCK_NG);
            } else {
                continue;                           // Repeat until messages are received
            }
        } else {
            rbuf_idx += length;                       // Update the receive data storage position
            rcv_size += length;                       // Update the number of receive data
            if(rcv_size >= RECV_ANS_1)               // Have all response messages been received?
                break;                               // Stop repeating as messages have been received
        }
    }
    r_buf[rbuf_idx] = '\0'; // Set NULL at the end of receive data
    printf("\n receive data\n%s\n",r_buf);

    strcpy(s_buf, "01FF000A4420000000000500"); // D0 to D4 batch read request (1E frame)
    length=(int)strlen(s_buf);
    if(send(socketno,s_buf,length,0)==SOCKET_ERROR){ // Data sending
        Sockerror(ERROR_SEND);                     // Error handling
        return (SOCK_NG);
    }
    printf("\n send data\n%s\n",s_buf);

    // Perform receiving size check and receiving processing simultaneously
    rbuf_idx = 0; // Receive data storage head index initialization
    rcv_size = 0; // Initialize the number of receive data
    while(1) {
        length = recv(socketno, &r_buf[rbuf_idx], (BUF_SIZE - rbuf_idx), 0);
        // Response data receiving
        if(length == 0) { // Is connection cut off?
            Sockerror(ERROR_RECIEVE); // Error handling
            return (SOCK_NG);
        }
        if(length == SOCKET_ERROR) {
            nErrorStatus = WSAGetLastError();
            if(nErrorStatus != WSAEWOULDBLOCK) {
                Sockerror(ERROR_RECIEVE); // Error handling
                return (SOCK_NG);
            } else {
                continue; // Repeat until messages are received
            }
        } else {
            rbuf_idx += length; // Update the receive data storage position
            rcv_size += length; // Update the number of receive data
            if(rcv_size >= RECV_ANS_2) // Have all response messages been received?
                break; // Stop repeating as messages have been received
        }
    }
    r_buf[rbuf_idx] = '\0'; // Set NULL at the end of receive data
    printf("\n receive data\n%s\n", r_buf);

```

```

    if(shutdown(socketno,2)!=SOCK_OK){
        Sockerror(ERROR_SHUTDOWN);
        return(SOCK_NG);
    }
    // Processing to disable sending/receiving
    // Error handling
    if(closesocket(socketno)!=SOCK_OK){
        Sockerror(ERROR_CLOSE);
        return(SOCK_NG);
    }
    // Close processing
    // Error handling
    Closeflag=FLAG_OFF;
    WSACleanup();
    // Connection completion flag off
    // Release Winsock.DLL
    printf("\nFX3U-ENET-ADP Test End.\n\n Normally completed. \n");
    printf("Press any key to exit the program.\n");
    Dmykeyin=getchar();
    // Wait for key input
    return(SOCK_OK);
}

void Sockerror(int error_kind)
// Error handling function
{
    if(error_kind==ERROR_INITIAL){
        printf("Initial processing is abnormal.");
    }
    else{
        nErrorStatus=WSAGetLastError();
        switch(error_kind){
            case ERROR_SOCKET:
                printf("Failed to create socket.");
                break;
            case ERROR_BIND:
                printf("Failed to bind.");
                break;
            case ERROR_CONNECT:
                printf("Failed to establish connection.");
                break;
            case ERROR_SEND:
                printf("Sending failed.");
                break;
            case ERROR_RECIEVE:
                printf("Receiving failed.");
                break;
            case ERROR_SHUTDOWN:
                printf("Failed to shutdown.");
                break;
            case ERROR_CLOSE:
                printf("Failed to close normally.");
                break;
        }
    }
    printf("Error code is %d.\n", nErrorStatus);
    if(Closeflag==FLAG_ON){
        nErrorStatus=shutdown(socketno,2);
        nErrorStatus=closesocket(socketno);
        Closeflag=FLAG_OFF;
        // Shutdown processing
        // Close processing
        // Connection completion flag off
    }
    printf("Press any key to exit the program.\n");
    Dmykeyin=getchar();
    // Wait for a key input
    WSACleanup();
    // Release Winsock.DLL
    return;
}

```

Appendix C-2 Program example for communication using MC protocol -2

This section explains an example of an external device program that reads/writes data from/to the PLC. A sample program, its execution environment and contents of data communication are shown below.

- 1) Execution environment of the program example
 - a) The settings of the PLC side are the same as those of the execution environment described in Section C-1 1) a) and 3) of Appendix.
 - b) The settings of the external device side are the same as those of the execution environment described in Section C-1 1) b) of Appendix, except for the following including the software development:
 - Software development environment: Microsoft® Corporation Visual Basic® .NET
 - Arbitrary numbers are assigned for the IP address and port number.
 - c) The communication protocol is TCP/IP
- 2) Outline of the program example
With the A-compatible 1E frame command (01: batch read in word units), this program reads data from D0 to D4 (five points) of the PLC of the station on which the Ethernet adapter is mounted.
- 3) Outline of the sample program
 - a) Create a new project and form.
 - b) Create the (example) window shown in (4) below using "Button" and "List Box" in the toolbox.
 - c) Create the program shown in (5).
- 4) Window example (Form 1)

(Object name)

Start

Connect to the Ethernet adapter
and perform communication

1st Output

Display data that was read from
the Ethernet adapter

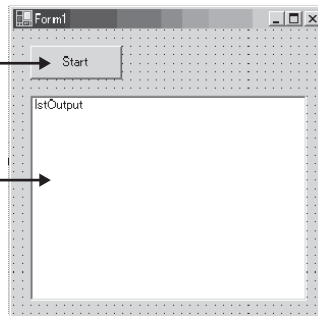

5) Sample program (Form 1)

Parts in *italic* are created automatically by Visual Basic® .NET, so no input is required.
Only input where written in **bold**.

Option Explicit On**Option Strict On****Imports System.Net.Sockets**

Public Class Form1

Inherits System.Windows.Forms.Form

#Region " Windows Code created by Form Designer "

Public Sub New()

MyBase.New()

' This call is necessary for Windows Form Designer.

InitializeComponent()

' InitializeComponent() Initialization is added after the call.

End Sub

' The Form overwrites dispose to execute post-processing in the component list.

Protected Overloads Overrides Sub Dispose(ByVal disposing As Boolean)

If disposing Then

If Not (components Is Nothing) Then

components.Dispose()

End If

End If

MyBase.Dispose(disposing)

End Sub

' Necessary for Windows Form Designer.

Private components As System.ComponentModel.IContainer

'Memo: The following procedure is necessary for Windows Form Designer.

'Change by using Windows Form Designer.

'Do not use code editor to change.

Friend WithEvents Start As System.Windows.Forms.Button

Friend WithEvents lstOutput As System.Windows.Forms.ListBox

<System.Diagnostics.DebuggerStepThrough> Private Sub InitializeComponent()

Me.Start = New System.Windows.Forms.Button

Me.lstOutput = New System.Windows.Forms.ListBox

Me.SuspendLayout()

,

'Start

,

Me.Start.Location = New System.Drawing.Point(16, 16)

Me.Start.Name = "Start"

Me.Start.Size = New System.Drawing.Size(88, 32)

Me.Start.TabIndex = 0

Me.Start.Text = "Start"

,

```

    'IstOutput
    ,
    Me.IstOutput.ItemHeight = 12
    Me.IstOutput.Location = New System.Drawing.Point(16, 64)
    Me.IstOutput.Name = "IstOutput"
    Me.IstOutput.Size = New System.Drawing.Size(264, 196)
    Me.IstOutput.TabIndex = 1
    ,
    'Form1
    ,
    Me.AutoScaleBaseSize = New System.Drawing.Size(5, 12)
    Me.ClientSize = New System.Drawing.Size(296, 273)
    Me.Controls.Add(Me.IstOutput)
    Me.Controls.Add(Me.Start)
    Me.Name = "Form1"
    Me.Text = "Form1"
    Me.ResumeLayout(False)

```

End Sub

#End Region

```

Private Sub Start_Click(ByVal sender As System.Object, ByVal e As System.EventArgs) Handles Start.Click
    Dim IPAddress As String
    Dim PortNum As Integer
    Dim Client As TcpClient
    Dim Buffer() As Byte
    Dim InBuff(1532) As Byte
    Dim TxCommand As String
    Dim RxResponse As String
    Dim Temp As String
    Dim j As Integer
    Dim Dreg(5) As Double
    Dim DregStr$
    Dim SubHeader$

    ' IP Address specification
    IPAddress = "172.16.56.99"
    ' Port Number specification
    PortNum = 10000

    Client = New TcpClient
    'Line connection processing
    Try
        Client.Connect(IPAddress, PortNum)
    Catch ex As Exception
        MsgBox("Connection with the server failed, and the following code was returned:
        "& ex.Message, 0, "connection error")
        Exit Sub
    End Try

```

```

'Read D0 to D4 (5 points) with the A-compatible 1E frame command.
TxCommand = "01ff000a442000000000500"
Buffer = System.Text.Encoding.Default.GetBytes(TxCommand.ToCharArray)
'Sending a read command
Client.GetStream().Write(Buffer, 0, Buffer.Length)
'Waiting for a response from an Ethernet adapter
While Not Client.GetStream().DataAvailable()
Application.DoEvents()
End While
If Client.GetStream().DataAvailable() Then
    Client.GetStream().Read(InBuff, 0, InBuff.Length)
    RxResponse = System.Text.Encoding.Default.GetString(InBuff)
    SubHeader = Mid$(RxResponse, 3, 2)
    If SubHeader = "00" Then 'Normal response
        Temp = "" 'Initialization of an output character string
        For j = 0 To 4
            DregStr$ = Mid(RxResponse, j * 4 + 5, 4)
            Dreg(j) = Val("&H" + DregStr$)
            Temp = Temp + Format(Dreg(j), "#####0") + " "
        Next
        IstOutput.Items.Insert(IstOutput.Items.Count, Temp)
    ElseIf SubHeader = "5B" Then ' In an abnormal response, an abnormal code is added.
        Temp = "Terminate Code = " & SubHeader & " Error Code = " & Mid$(RxResponse, 5, 2)
        IstOutput.Items.Insert(IstOutput.Items.Count, Temp)
    Else
        Temp = "Terminate Code = " & SubHeader
        IstOutput.Items.Insert(IstOutput.Items.Count, Temp)
    End If
    IstOutput.SelectedIndex = IstOutput.Items.Count - 1
End If
' Line disconnection processing
Client.GetStream().Close()
Client.Close()

End Sub
End Class

```

Appendix D: Differences with FX3U-ENET

The table below shows major differences between the FX3U-ENET-ADP and the FX3U-ENET.

✓ : Supported X : Not supported

Item		Summary	FX3U-ENET-ADP	FX3U-ENET
Communication Using MC Protocol	A-compatible 1E frame subset	Reading/writing data on the PLC main unit from/to external devices (The frame method is compatible with the A Series E71.)	✓	✓
Connection with MELSOFT products		Connecting MELSOFT products through TCP/IP communication (Two or more MELSOFT products can be connected at the same time.)	✓	✓
Fixed buffer communication		Sending/receiving arbitrary data to/from external devices.	X	✓
E-mail	Send	Sending/receiving data using E-mails.	X	✓
	Receive		X	✓
Direct connection to MELSOFT (Simple Connection)		Enabling direct connection (simple connection) to an MELSOFT product with only one Ethernet cable not via the hub (In direct connection, communication is enabled only by specifying the connection destination without setting the IP address.)	✓	X
Find CPU function		Searching for PLC main units connected to the same hub as MELSOFT, and displays the list of found PLC main units.	✓	X
Time setting function		Accessing the time information server (SNTP server) connected on the LAN, collecting the time information, and automatically setting the time to the PLC main unit.	✓ (SNTP server is required)	X
Router relay communication (router relay function)		Communicating via the router and gateway (In the router relay function, the Ethernet adapter/unit does not work as a router.)	✓	✓
For user connection	Connection number	User connection used for communication using the MC protocol and communication by MELSOFT connection (The application is set by parameters.)	Total of 4 connections MELSOFT connection + MC protocol <= 4	Total of 8 connections Fixed buffer communication <= 8 MELSOFT connection + MC protocol <= 4
Parameter setting		Providing various settings required for communication.	PLC Parameters of GX Works2	Sequence program (BFM setting), FX Configurator-EN
Parameter storage		Where set parameters are stored.	Parameter area of the main unit	Built-in flash memory of the FX3U-ENET
Data transfer rate		Ethernet communication speed.	100Mbps/10Mbps	100Mbps/10Mbps
Send frame format	Ethernet (V2.0)	Specifying the Ethernet header frame format for data link layer.	✓	✓
	IEEE802.3		X	✓
External device existence check (Existence confirmation function)	Confirmation by PING	Sending the PING message (ICMP echo) for checking the existence to an external device, and closing the corresponding connection if response is not given.	X	✓
	Confirmation by KeepAlive	Confirming that the connection opened by the TCP protocol remains established (open) by sending the ACK message for confirmation to an external device and waiting for response.	✓ (Interval time 5 seconds, 8 retry count anchoring)	✓
Corresponding PLC		Connectable PLC.	FX3U/FX3UC	FX3G/FX3U/FX3UC

FX3U-ENET-ADP User's Manual

Item	Summary	FX3U-ENET-ADP	FX3U-ENET
Connection system	Connection method to the PLC.	Adapter connection (Only the adapter final stage (leftmost position) connectable)	FX3U bus connection
Mounting position	Mounting position when connected to the PLC.	The left side of the main unit	The right side of the main unit
Number of I/O occupied points	Number of I/O points occupied when connected to the PLC.	0 point	8 point

Appendix E: Document, others

Appendix E-1 Setting Value Recording Sheets

This section provides setting value recording sheets for parameters set with GX Works2. Make copies as needed.

Setting value recording sheet No.	GX Works2 setting screen
Recording sheet 1	Ethernet Adapter
Recording sheet 2	Ethernet Adapter Open Setting
Recording sheet 3	Ethernet Adapter Time Setting
Recording sheet 4	Ethernet Adapter Log Record Setting

Recording sheet 1

[Adapter number]

GX Works2 setting screen	Data item		Setting data	
			Check/Setting value	Remark
Ethernet Adapter	Channel		Channel 1	
			Channel 2	
	IP address setting	Input format	Decimal	IP address Input format
			Hexadecimal	
		IP address	. . .	Adjust to input format
		Subnet mask pattern	. . .	Adjust to input format
	Default router IP address	. . .	Adjust to input format	
	Communication data code		Binary Code	
			ASCII Code	
	Disable direct connection to MELSOFT			Checked/ Unchecked
	Do not respond to search for CPU on network			Checked/ Unchecked

Recording sheet 2

[Adapter number]

GX Works2 setting screen	Data item		Setting data	
			Check/Setting value	Remark
Ethernet Adapter Open Setting	Connection No.	Protocol	Not Set	
			TCP	
			UDP	
		Open System	MELSOFT connection	
			MC protocol	
		Host Station Port No.		
		Destination IP Address		Adjust to input format
	Destination Port No.			
	Connection No.	Protocol	Not Set	
			TCP	
			UDP	
		Open System	MELSOFT connection	
			MC protocol	
		Host Station Port No.		
		Destination IP Address		Adjust to input format
	Destination Port No.			
	Connection No.	Protocol	Not Set	
			TCP	
			UDP	
		Open System	MELSOFT connection	
			MC protocol	
		Host Station Port No.		
		Destination IP Address		Adjust to input format
	Destination Port No.			
Connection No.	Protocol	Not Set		
		TCP		
		UDP		
	Open System	MELSOFT connection		
		MC protocol		
	Host Station Port No.			
	Destination IP Address		Adjust to input format	
Destination Port No.				

Recording sheet 3

[Adapter number]

GX Works2 setting screen	Data item	Setting data	
		Check/Setting value	Remark
Ethernet Adapter Time Setting	SNTP Function Setting	Use	
		Not Used	
	SNTP Server IP Address		Adjust to input format
	Input Format	Decimal	IP address input format
		Hexadecimal	
	Time Zone		
	Execute time setting at turn ON		
	On-error Action	Stop	
		Continue	
Execution Interval			
Execution Time			

B Version Information

C Program Examples

D Differences with FX3U-ENET

E Document, others

Recording sheet 4

[Adapter number]

GX Works2 setting screen	Data item		Setting data		Remark	
			Check/Setting value			
Ethernet Adapter Log Record Setting	Error log	Set error log save destination		<input type="checkbox"/>	Checked/ Unchecked	
		Number of Records				
		Device Range	Head device type		<input type="checkbox"/>	D
					<input type="checkbox"/>	R
			Head device number			
	Last device number					
	Access log	Set access log save destination		<input type="checkbox"/>	Checked/ Unchecked	
		Number of Records				
		Device Range	Head device type		<input type="checkbox"/>	D
					<input type="checkbox"/>	R
			Head device number			
	Last device number					
	Save destination for the result of time setting	Set save destination for the result of time setting		<input type="checkbox"/>	Checked/ Unchecked	
		Device Range	Head device type		<input type="checkbox"/>	D
					<input type="checkbox"/>	R
Head device number						
Last device number						

Appendix E-2 Processing Time

Calculate the minimum processing time for MC protocol using the expressions below.

Note that the processing time may become longer depending on the load factor on the network (how congested the line is), the window size of each connected device, the number of connections used concurrently, and how the system is configured. Use the values obtained from the expressions below as a guideline for the processing time when communication is performed using only one connection.

- Minimum processing time of communication using MC protocol (batch read and batch write)

$$Tfs = Ke + (Kdt \times Df) + Scr \times \text{number of scans required for processing} + \text{ACK processing time of external device}$$

Tfs : Time from when Ethernet adapter receives request data from personal computer until it completes processing (unit: ms) *1

Ke, Kdt : Constant (refer to the table below)

Df : Number of request data words + number of response data words (Application data part)

Scr : Scan time

- *1. The timing sequence from when the Ethernet adapter receives the request data from the personal computer until it completes processing is shown below.

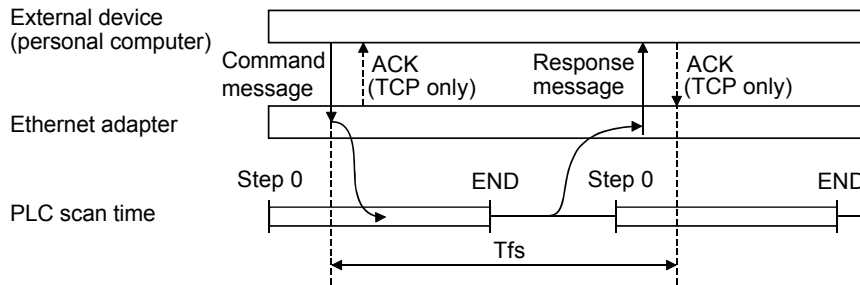

Communication content		Communication using TCP/IP		Communication using UDP/IP	
		Ke	Kdt	Ke	Kdt
Batch read	Data communication using binary code	8	0.054	8	0.059
	Data communication using ASCII code	8	0.056	7	0.067
Batch write	Data communication using binary code	9	0.049	7	0.051
	Data communication using ASCII code	8	0.056	8	0.051

[Calculation example 1]

Calculate the required time (unit: ms) to complete the processing of a data request from a PC after receiving it, when the Ethernet adapter and the PC perform TCP/IP communication and read 32 points of ASCII code data from the data register (D) in the PLC using MC protocol communication.

- Assume that the scan time of the Ethernet adapter installed station is 40 ms:
 $52.37 + \text{ACK processing time of the external device (ms)} \doteq$
 $8 + (0.056 \times (12 + 66)) + 40 \times 1 + \text{ACK processing time of the external device}$
 Command data length = 12 words
 Response data length = 66 words

[Calculation example 2]

Calculate the required time (unit: ms) the Ethernet adapter takes to complete the processing of a data request from a PC after receiving it, when the Ethernet adapter and the PC performs TCP/IP communication and writes 32 points of ASCII code data to the data register (D) in the PLC using MC protocol communication.

- Assume that the scan time of the Ethernet adapter installed station is 40 ms:
 $52.37 \text{ (ms)} \doteq 8 + (0.056 \times (76 + 2)) + 40 \times 1$
 Command data length = 76 words
 Response data length = 2 words

Appendix E-4 References

For details on TCP/IP, refer to the DDN Protocol Handbook (3 volumes).

Publisher

DDN Network Information Center
SRI International
333 Ravenswood Avenue, EJ291
Menlo Park, California 94025

RFC Number

TCP RFC793
UDP RFC768
IP RFC791
ICMP RFC792
ARP RFC826

Appendix E-5 Differences between Ethernet and IEEE802.3

The following shows the Ethernet header in the data link layer supported by the Ethernet adapter.

Ethernet data link layer header	Ethernet adapter
Ethernet frame (V 2.0) specification	✓
IEEE802.3 (ISO/IEC8802.3) frame specification	✓

1) Ethernet

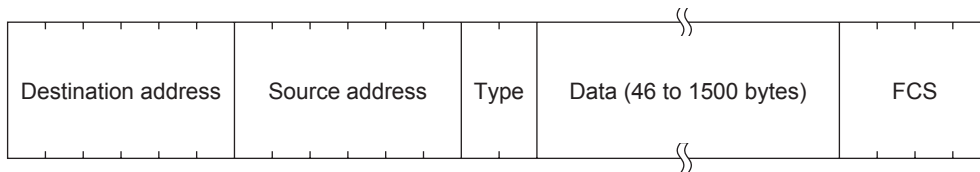

2) IEEE802.3

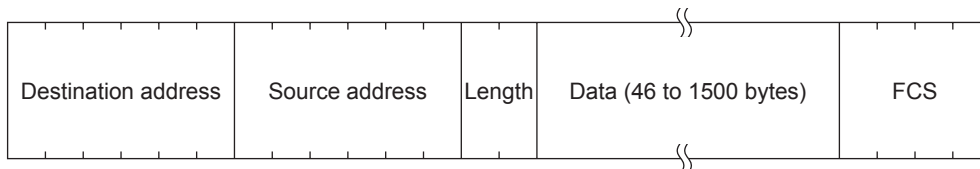

Appendix E-6 ICMP Protocol Supported by Ethernet adapter

The following table outlines the types of ICMP supported by the Ethernet adapter and the processing performed by the Ethernet adapter.

ICMP Type	ICMP name/description	Processing by the Ethernet adapter
0	Echo Reply Result of IP packet loopback	Upon receiving an Echo Request, the Ethernet adapter sends this message.
8	Echo Request Requests loopback of IP packet	If destination existence confirmation is set in the buffer memory, the Ethernet adapter sends this message when attempting to confirm the existence of the target.*1
Others	-	Ignored by the Ethernet adapter. (Not supported)

*1. The Ethernet adapter can simultaneously receive two ICMP ECHO requests (type 8, Ping message), which are used for existence confirmation, etc., and handles them accordingly. When three or more ICMP ECHO requests are received at the same time, the third and succeeding requests will be ignored. If a response is not returned to the external device when an ICMP ECHO request is sent to the Ethernet adapter, send an ICMP ECHO request to the Ethernet adapter again. The Ethernet adapter is able to receive a maximum of 1460 bytes ICMP message at one time. Do not send an ICMP message request exceeding 1460 bytes to the Ethernet adapter.

MEMO

Warranty

Please confirm the following product warranty details before using this product.

1. Gratis Warranty Term and Gratis Warranty Range

If any faults or defects (hereinafter "Failure") found to be the responsibility of Mitsubishi occurs during use of the product within the gratis warranty term, the product shall be repaired at no cost via the sales representative or Mitsubishi Service Company. However, if repairs are required onsite at domestic or overseas location, expenses to send an engineer will be solely at the customer's discretion. Mitsubishi shall not be held responsible for any re-commissioning, maintenance, or testing on-site that involves replacement of the failed module.

[Gratis Warranty Term]

The gratis warranty term of the product shall be for one year after the date of purchase or delivery to a designated place. Note that after manufacture and shipment from Mitsubishi, the maximum distribution period shall be six (6) months, and the longest gratis warranty term after manufacturing shall be eighteen (18) months. The gratis warranty term of repair parts shall not exceed the gratis warranty term before repairs.

[Gratis Warranty Range]

- 1) The range shall be limited to normal use within the usage state, usage methods and usage environment, etc., which follow the conditions and precautions, etc., given in the instruction manual, user's manual and caution labels on the product.
- 2) Even within the gratis warranty term, repairs shall be charged for in the following cases.
 - a) Failure occurring from inappropriate storage or handling, carelessness or negligence by the user. Failure caused by the user's hardware or software design.
 - b) Failure caused by unapproved modifications, etc., to the product by the user.
 - c) When the Mitsubishi product is assembled into a user's device, Failure that could have been avoided if functions or structures, judged as necessary in the legal safety measures the user's device is subject to or as necessary by industry standards, had been provided.
 - d) Failure that could have been avoided if consumable parts (battery, backlight, fuse, etc.) designated in the instruction manual had been correctly serviced or replaced.
 - e) Relay failure or output contact failure caused by usage beyond the specified Life of contact (cycles).
 - f) Failure caused by external irresistible forces such as fires or abnormal voltages, and failure caused by force majeure such as earthquakes, lightning, wind and water damage.
 - g) Failure caused by reasons unpredictable by scientific technology standards at time of shipment from Mitsubishi.
 - h) Any other failure found not to be the responsibility of Mitsubishi or that admitted not to be so by the user.

2. Onerous repair term after discontinuation of production

- 1) Mitsubishi shall accept onerous product repairs for seven (7) years after production of the product is discontinued. Discontinuation of production shall be notified with Mitsubishi Technical Bulletins, etc.
- 2) Product supply (including repair parts) is not available after production is discontinued.

3. Overseas service

Overseas, repairs shall be accepted by Mitsubishi's local overseas FA Center. Note that the repair conditions at each FA Center may differ.

4. Exclusion of loss in opportunity and secondary loss from warranty liability

Regardless of the gratis warranty term, Mitsubishi shall not be liable for compensation of damages caused by any cause found not to be the responsibility of Mitsubishi, loss in opportunity, lost profits incurred to the user or third person by Failures of Mitsubishi products, special damages and secondary damages whether foreseeable or not, compensation for accidents, and compensation for damages to products other than Mitsubishi products, replacement by the user, maintenance of on-site equipment, start-up test run and other tasks.

5. Changes in product specifications

The specifications given in the catalogs, manuals or technical documents are subject to change without prior notice.

6. Product application

- 1) In using the Mitsubishi MELSEC programmable logic controller, the usage conditions shall be that the application will not lead to a major accident even if any problem or fault should occur in the programmable logic controller device, and that backup and fail-safe functions are systematically provided outside of the device for any problem or fault.
- 2) The Mitsubishi programmable logic controller has been designed and manufactured for applications in general industries, etc. Thus, applications in which the public could be affected such as in nuclear power plants and other power plants operated by respective power companies, and applications in which a special quality assurance system is required, such as for Railway companies or Public service purposes shall be excluded from the programmable logic controller applications. In addition, applications in which human life or property that could be greatly affected, such as in aircraft, medical applications, incineration and fuel devices, manned transportation, equipment for recreation and amusement, and safety devices, shall also be excluded from the programmable logic controller range of applications. However, in certain cases, some applications may be possible, providing the user consults their local Mitsubishi representative outlining the special requirements of the project, and providing that all parties concerned agree to the special circumstances, solely at the users discretion.

Revised History

Date	Revision	Description
2/2012	A	First Edition

FX3U-ENET-ADP

USER'S MANUAL



HEAD OFFICE: TOKYO BUILDING, 2-7-3 MARUNOUCHI, CHIYODA-KU, TOKYO 100-8310, JAPAN
HIMEJI WORKS: 840, CHIYODA CHO, HIMEJI, JAPAN

MODEL	FX3UENETADP-U-E
MODEL CODE	09R725